

TENMARS

Temperature / Humidity Meter

TM-730

User's Manual



HB2TM7300001

TENMARS ELECTRONICS CO., LTD

CONTENTS

| | | |
|-----------|---|----------|
| 1 | PREFACE..... | 1 |
| 2 | CHARACTERISTICS | 1 |
| 3 | SPECIFICATIONS | 1 |
| 3.1 | <i>General Specifications</i> | <i>1</i> |
| 3.2 | <i>Electrical Specification: (Temperature: 25°C, Humidity: <90% RH).....</i> | <i>2</i> |
| 3.3 | <i>Accuracy:.....</i> | <i>2</i> |
| 4 | OPERATING INSTRUCTIONS..... | 3 |
| 4.4 | <i>LCD Display Functions:</i> | <i>3</i> |
| 4.5 | <i>Instrument description.....</i> | <i>3</i> |
| 4.6 | <i>MODE:</i> | <i>3</i> |
| 4.7 | <i>CAL/°C/°F Button:</i> | <i>4</i> |
| 4.8 | <i>MAX/MIN/AVG Button.....</i> | <i>4</i> |
| 4.9 | <i>Data Hold Button</i> | <i>4</i> |
| 4.10 | <i>Power Button:.....</i> | <i>5</i> |
| 4.11 | <i>Auto Power Off:.....</i> | <i>5</i> |
| 4.12 | <i>Enable/Disable Auto Power Off:.....</i> | <i>5</i> |
| 5 | End of life | 5 |
| 6 | Accessories: | 5 |
| 7 |  Warning and Precautions: | 6 |
| 8 | EMC..... | 6 |
| 9 | Accessories: | 7 |
| 10 | Battery Replacement..... | 7 |

1 PREFACE

Thank you for your patronage please read these operating instructions carefully so that you may correctly operate the Temperature / Humidity Meter, allowing it to perform all its intended functions at optimum level.

The Temperature /Humidity Meter use a highly accurate sensor chip to measure relative humidity and temperature. It is perfect for many industrial applications, laboratory and other types of work locations.

2 CHARACTERISTICS

- Dual display of temperature and humidity.
- °C / °F alternate.
- Simultaneously hold both temperature and humidity readings.
- Simultaneously hold both maximum and minimum and average readings (MAX/MIN/AVG).
- Auto-power off.
- DEW-POINT and WET-BULB temperature measurement.

3 SPECIFICATIONS

3.1 General Specifications

- Display : Dual LCD display. The maximum value on the primary display is 999. The maximum value on secondary display is 999.
- Low Battery Indicator : When the LCD displays "  " symbol, please replace the battery.
- Sampling Rate : 1 sample per second.
- Power Supply : 2 batteries 1.5V AAA MN2400 LR03 AM4.
- Battery Life : 50 hours during consecutive use.
- Dimensions : 107 × 48 × 23 mm (L × W × H)

- Weight : 80g (excluding the battery)
- Accessories : User manual, battery, and carrying case.
- Operating Temperature and Humidity : 0°C ~ +60°C, <95% RH. (non-condensing)
- Storage Temperature and Humidity : -10 to 60°C, <70% RH. (non-condensing)

3.2 Electrical Specification: (Temperature: 25°C, Humidity: <90% RH)

- Temperature Measurement Range : -20.0°C ~ +50.0°C (-4.0°F - +122.0°F).
- Humidity Measurement Range : 1.0% ~ 99 %RH.

3.3 Accuracy:

- Humidity : ±3.5% for 20~90%.
- ± 5% for 1~19.9 and 90.1~99.
- Temperature : ± 1.0°C , ±1.8°F.

4 OPERATING INSTRUCTIONS

4.4 LCD Display Functions:

| | |
|---|---|
| <p>The diagram shows the LCD display with the following callouts: 1. Battery status icon; 2. Primary display digits; 3. Secondary display digits; 4. Auto-power off indicator; 5. Data hold indicator; 6. MAX data hold indicator; 7. AVG reading indicator; 8. MIN data hold indicator; 9. %RH indicator; 10. °C temperature unit; 11. DEW-POINT indicator; 12. WET-BULB indicator; 13. °F temperature unit.</p> | <ol style="list-style-type: none"> 1. Low Battery Detect 2. Primary Display 3. Secondary Display 4. Auto-Power Off Indicator 5. Data Hold 6. MAX Data Hold 7. AVG Reading 8. MIN Data Hold 9. Relative Humidity 10. °C Temperature unit 11. DEW-POINT 12. WET-BULB 13. °F Temperature unit |
|---|---|

4.5 Instrument description

| | |
|--|---|
| <p>The diagram shows the front panel of the instrument with the following callouts: 1. Sensor; 2. LCD; 3. °C/°F Temperature unit and calibration button; 4. DEW-POINT/WET-BULB/Temperature button; 5. MAX/MIN/AVG Reading button; 6. Data hold button; 7. On/Off button.</p> | <ol style="list-style-type: none"> 1. Sensor 2. LCD 3. °C/°F Temperature unit and calibration button 4. DEW-POINT/WET-BULB/Temperature button 5. MAX/MIN/AVG Reading button 6. Data hole button 7. On/Off button |
|--|---|

4.6 MODE:

- During normal measurement, press “MODE” button to switch temperature → Dew-point → Wet-bulb in sequence.

4.7 CAL/°C/°F Button:

- Calibration point 55%RH and 25°C.
 1. Prepares 55%RH or 25°C environment.
 2. Press CAL button and POWER button more than 2 second to calibration.
 3. Put the meter in 55%RH or 25°C environment
 4. Presses the MODE key to be select humidity or temperature (humidity and temperature may alone adjustment)
 5. Press CAL button more than 2 second to complete the adjustment.
- 6. If must give up adjust please press the "" key.
- Press this less than 1 second to alternative °C or °F unit.

4.8 MAX/MIN/AVG Button

The MAX MIN feature reads and updates the display to show the maximum or minimum or AVG value measured after you press the MAX MIN button. Pressing the MAX MIN button for less than 1 second will put the meter into a mode of displaying the maximum, minimum, average readings. Each time the MAX button is pressed, the meter will cycle between MAX and MIN and AVG readings. Press the MAX MIN button for more than 2 seconds to disable this feature.

4.9 Data Hold Button

Press "HOLD" button to enter the Data Hold mode. The LCD will display "HOLD" symbol and hold both the temperature and humidity readings at the same time. Press "HOLD" button again to exit this mode.



4.10 Power Button:

Press the  button more than 2 second to power on the meter.

4.11 Auto Power Off:

To save battery life, the meter powers down automatically after approximately 12 minutes of inactivity.

4.12 Enable/Disable Auto Power Off:

You can disable or enable Auto Power Off by pressing the  button more than 2 second the LCD  symbol will disappear or enable.

5 End of life

| | |
|---|---|
|  | <p style="text-align: center;">Caution</p> <p>This symbol indicates that equipment and its accessories shall be subject to a separate collection and correct disposal.</p> |
|---|---|

6 Accessories:

- User manual.
- 1.5V battery (AAA MN2400 LR03 AM4)*2.
- Carrying case.

7 **Warning and Precautions:**

- Please refrain from operating the Temperature / Humidity Meter in an environment with drastic temperature and humidity changes. Do not store the thermometer in an environment prone to high temperature, high humidity, or vigorous vibrations. Avoid exposing the thermometer in a chemical-contaminated environment.
- When not using the Temperature / Humidity Meter for an extended period of time, remove the battery to avoid damage to the thermometer due to the leaking battery fluid.
- Cleaning and Maintenance : Cigarette ashes and dust on the humidity sensor can slow down the sensor's response time, while causing inaccuracy in measurements. Clean up the sensor periodically by simply blowing away the dust particles. Do not apply water or other chemical solvent like alcohol when cleaning.
- Do not place the Temperature / Humidity Meter inside any liquid to prevent damage to the Thermometer.

8 **EMC**

 -EMC : EN61326-1 This product complies with requirements of the following European Community Directives: 89/336/EEC (Electromagnetic Compatibility) and 73/23/EEC (Low Voltage) as amended by 93/68/EEC (CE Marking). However, electrical noise or intense electromagnetic fields in the vicinity of the equipment may disturb the measurement circuit. Measuring instruments

will also respond to unwanted signals that may be present within the measurement circuit. Users should exercise care and take appropriate precautions to avoid misleading results when making measurements in the presence of electronic interference.

9 Accessories:

- User manual.
- 1.5V battery (AAA MN2400 LR03 AM4)*2.
- Carrying case.

10 Battery Replacement

1. Turn off the meter and slide out the battery cover.
2. Remove the low batteries.
3. Replace same type batteries (1.5V LR 03 AAA)

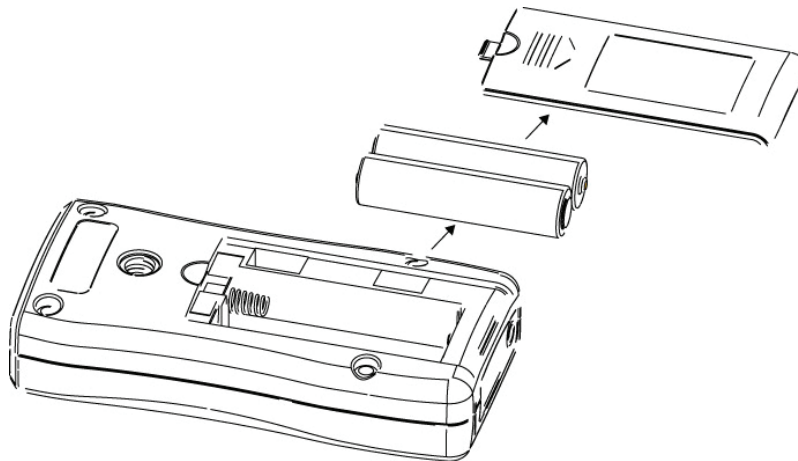

TENMARS



Professional Electrical and Environment Test & Measurement Instruments:

LED light meter, Temperature & Humidity meter
Infrared Thermometer, Sound level meter
Light meter, EMF meter, UV Light meter, RF meter
Hot wire Anemometer, Co meter
Anemometer, Lan cable tester, Co2 meter
Solar power meter, Radiation meter,
Clamp meter, Multimeter
Phase Rotation tester, Digital Insulation tester

**Our products of high quality are selling well
all over the world**

TENMARS ELECTRONICS CO., LTD
6F, 586, RUI GUANG ROAD, NEIHU,
TAIPEI 114, TAIWAN.

E-mail: service@tenmars.com

<http://www.tenmars.com>