



testo 545  
Luminous intensity measuring instrument

Instruction manual

en



Contents .....	2
Initial operation .....	4
First measurement .....	5
Instrument description	
-Keypad/Connection assignment .....	6
-Display .....	7
Overview of controls .....	8-9
Current measurement .....	10
Switching on .....	10
Saving, Printing .....	10
Measurement functions .....	11
Freezing readings .....	11
Maximum readings .....	11
Minimum readings .....	11
Multi-point mean calculation .....	12
Timed mean calculation .....	12
Location selection .....	14
Measuring range switchover function .....	14
Memory settings .....	15
Overview .....	15
Manual / Automatic saving .....	16
Reading out or printing memory .....	17
Clearing memory contents / Sample printouts .....	18



According to the conformity certificate, the instruments fulfill **2004/08/EEC** guidelines.

© 1999 Copyright Testo GmbH & Co.  
The software and software structure included in the product **testo 545** are protected by copyright laws worldwide.

Instrument configuration .....	.19
Power save function .....	.19
Setting date/time .....	.19
Unit selection / Factory reset .....	.20
Power supply .....	.20
Error messages .....	.21
Technical data .....	.22
Ordering data .....	.23

### Please read prior to measurement



Do not measure on live parts.

Observe storage and transport temperature and max. operating temperature (e.g. protect measuring instrument from direct sunlight)

The V24 cable (PC connection) can be inserted anytime.  
A simultaneous print command is not possible if the PC cable is connected.

Opening the instrument, inexpert handling and use of force cancels your warranty.

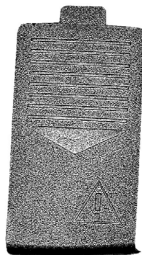
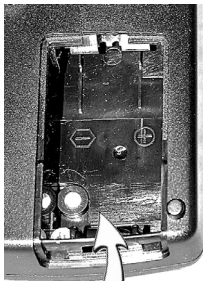

### Putting in the batteries

9V block battery is included in delivery.

Open the battery compartment at the back of the instrument.  
Put in block battery. **Observe polarisation**  
Close battery compartment.

Refer to "Power supply" Chapter for more information on alternative power supply, charge, battery quality.

**The description of the instrument and an overview of the controls provide a quick introduction.**



*Instrument configuration*

You will receive up to date readings once the instrument is switched on. However, you will still need to update or define the data in the instrument:

- ⇒ Date/Time:
- ⇒ Auto Off:
- ⇒ Units:

Some things can only be set via PC software (See Ordering data):

- ⇒ Location name (8 characters)
- ⇒ Log heading (24 characters), e.g. your company name - is printed when the readings are printed.

# Instrument description

## Keyboard/Connection assignment

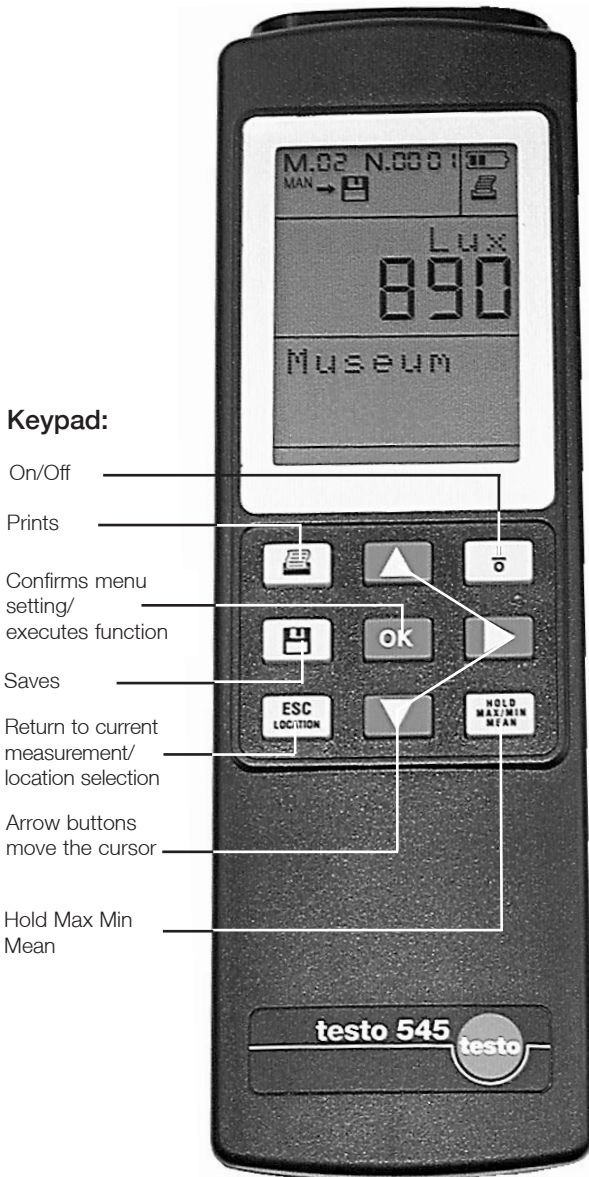

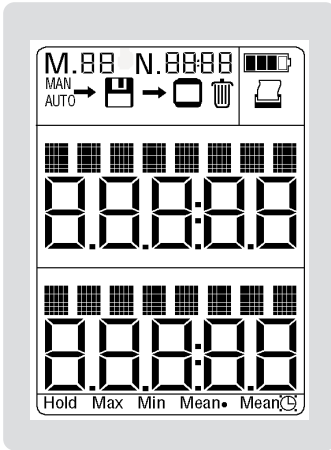

→ The symbols on the top line are explained below

→ Name of input socket and parameter

→ Displays reading in line 1

→ Name of location

→ Time/number of points in mean calculation

→ Displays measurement functions

### Explanation of symbols:

M. 00

Counter for the log number in the memory.

When saving manually: number of the measurement saved.

When saving automatically: number of the measurement series. This counter is needed in order to be able to find single logs or a measurement series when reading out the memory.

N. 0000

Counter for saving a measurement cycle (required only for automatic saving). The measurement cycle in a measurement series can be found.



Manual saving of a single measurement by pressing the save button .

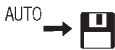

Automatic saving program has been set up.

Saving is activated by pressing the button.



Symbol for reading contents of memory on display.



Symbol for deleting memory contents.



If this symbol appears, the printing function is activated.

The symbol flashes while data is being transmitted. You can print on the desktop printer by pressing the print button .



Shows capacity of battery and rechargeable battery.



If the inner segment no longer appears (symbol flashes), the battery has to be changed or the rechargeable battery has to be recharged. The instrument switches itself off automatically after 1 minute.

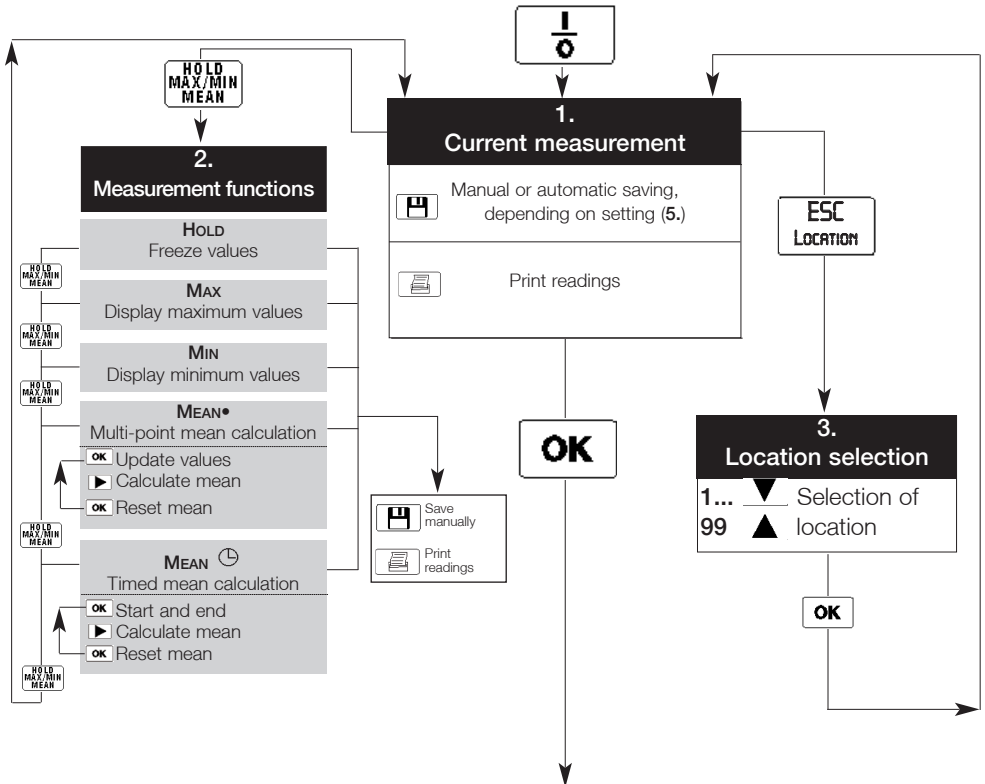

## 4. Measuring range switchover function

Selected parameter	
Lux	Switching from resolution of 1 Lux (meas. range 32,000 Lux) to 10 Lux (meas. range 100,000 Lux) *
fc	Switching from resolution of 0.1 fc (meas. range 3200 fc) to 1 fc (meas. range 10.000 fc)

\* Multiply displayed value by 10.



# Overview of controls

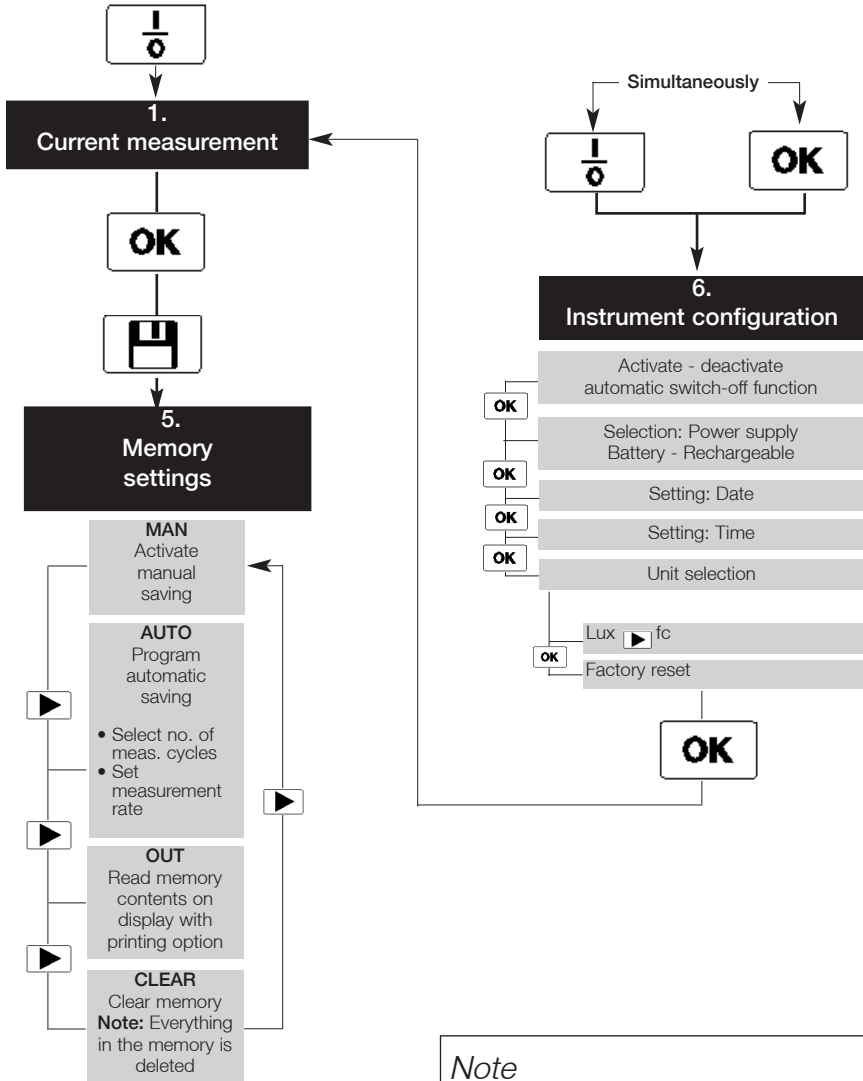

### Note

Flashing display is activated and is confirmed by pressing **OK**.

# Current measurement

Switching on / Saving / Printing

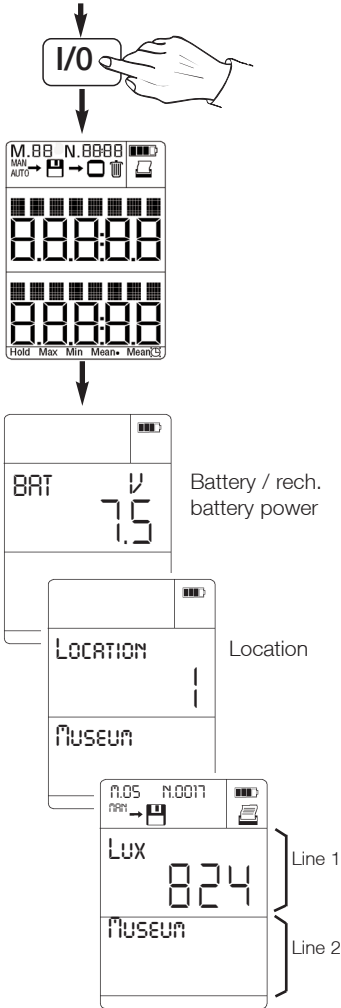

It is possible to activate the following functions during measuring at the touch of a button:



### Save readings.

Manual or automatic saving is determined by the save setting (Chapter 5).



### Print readings.

# Measurement functions

## Freezing values, maximum readings, minimum readings

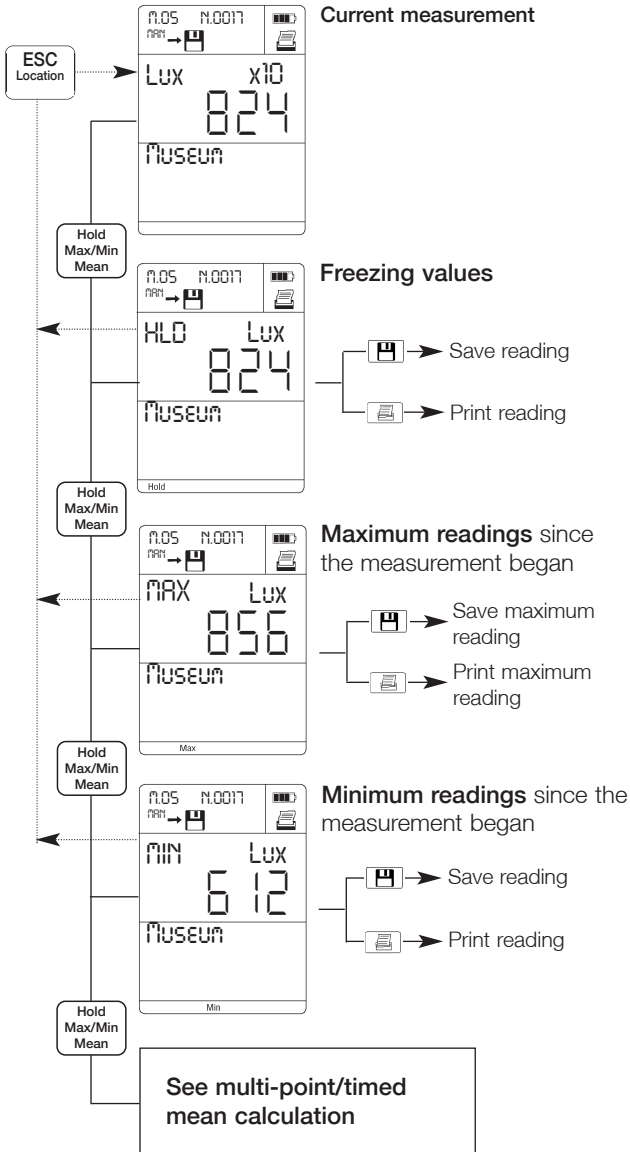

# Measurement functions

## Multi-point mean calculation Mean•

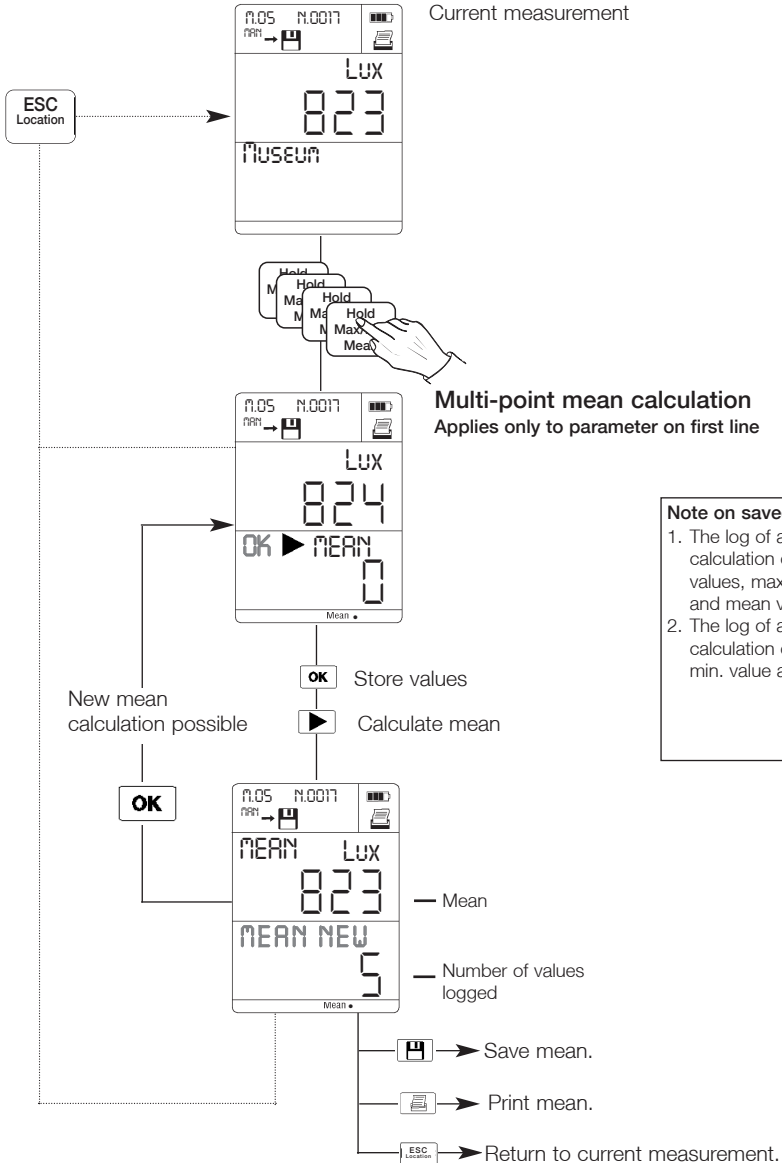

**Note on saved or printed logs:**

1. The log of a **multi-point** mean calculation contains single values, max. value, min. value and mean value.
2. The log of a **timed** mean calculation contains max. value, min. value and mean value.

# Measurement functions

Current measurement

Timed mean calculation **Mean** ⌚

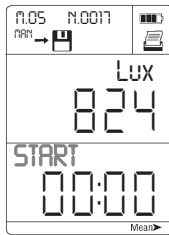
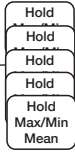

**OK** Start timed mean calculation.

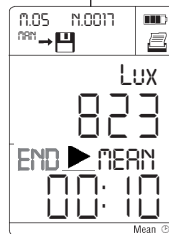

**OK** Finish timed mean calculation.

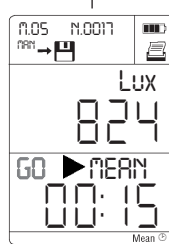

**OK** Continue timed mean calculation

or

**▶** Calculate mean.

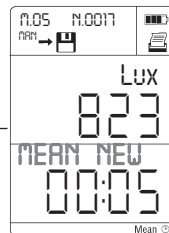

Mean

Duration of mean calculation

New mean calculation is possible

**☰** Save mean.

**🖨** Print mean.



or **▶** Return to current measurement.

**Note on saved or printed logs:**

1. The log of a **multi-point** mean calculation contains single values, max. value, min. value and mean value.
2. The log of a **timed** mean calculation contains max. value, min. value and mean value.

# Location selection

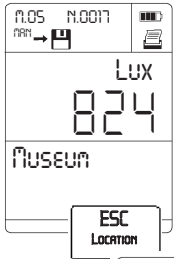

1. Current measurement

The location names Location 1 to 99 are specified by the factory.

You can load your own location names (8 characters) onto your instrument using PC software.



Selection of location.



Return to current measurement

**OK** → Confirm selection and return to measurement.

or :

From now on all measured data which is saved or printed is linked to the selected location or product names.

## Measuring range switchover function



Switching between measuring range and lux or fc resolution

LUX ► LUX x 10 / 0.1 FC ► FC

The resolution selected flashes.

→ Select

**OK** → Confirm selection and return to measurement.

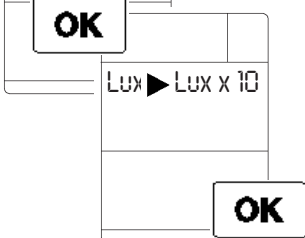



Resolution	Meas. range
1 Lux	32,000 Lux
10 Lux *	100,000 Lux

Resolution	Meas. range
0.1 fc	3200 fc
1 fc	10,000 fc

\* Multiply displayed value by 10.

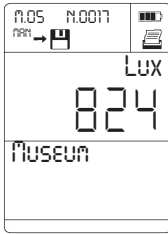
### 1. Current measurement



Press the **OK** button to get to the memory settings mode.  
Confirm flashing save symbol  via  button.

4 memory settings are possible. Select the required saving option by pressing :

MAN ► AUTO ► OUT ► CLEAR ► MAN ► ...

The symbol corresponding to the selection appears in the top line.  
The function is activated with **OK**.

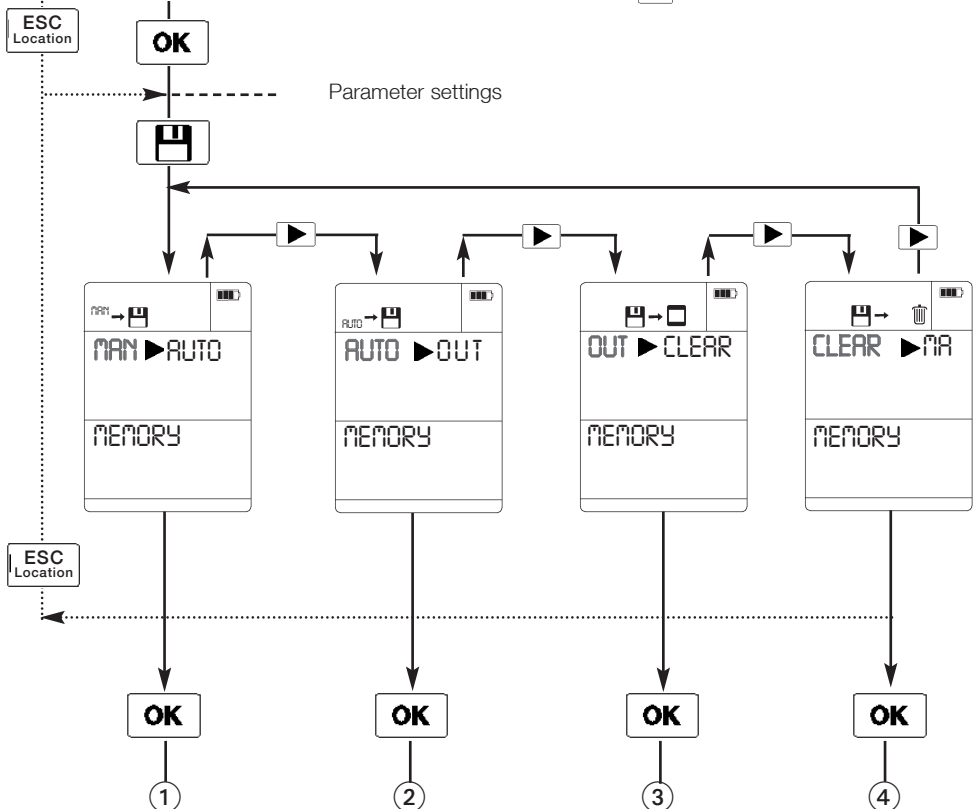

# Memory settings

## Manual / Automatic saving

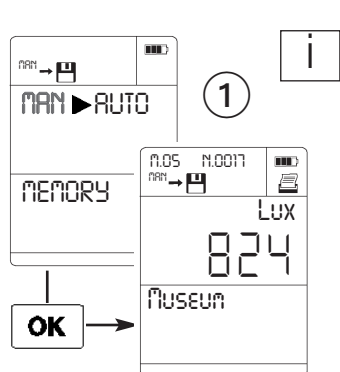

Press the **OK** button to get to the memory settings mode.  
Confirm flashing save symbol via button.

MAN

### Manual saving:

Each time is pressed a log of the measurement is saved in the instrument and includes measured values, location, date and time. The counter in the top left corner of the display shows the number of logs saved for this location.

### Saving a log with timed or multi-point mean calculation :

The log includes MIN value, MAX value and mean of the measurement and also single values in multi-point mean calculations.

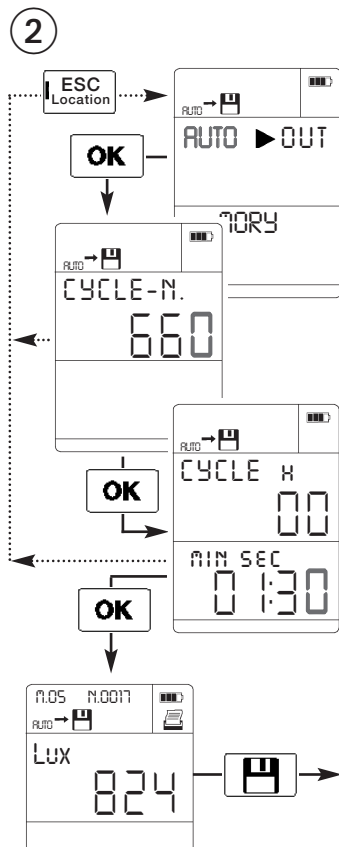

AUTO

### Automatic saving:

When this saving function is set, the instrument automatically accepts the measured values at fixed intervals and saves them (=logger operation).  
The number of measuring cycles (CYCLE-N.) to be saved and intervals (CYCLE) have to be programmed:

#### 1. Cycle-N.

The instrument automatically offers the maximum possible number of measuring cycles. Set required number using / / .

Confirm set value by pressing **OK**.

#### 2. Cycle

Select interval in which the measured values are to be saved. The blinking position can be changed using . Confirm set value by pressing **OK**.

Automatic saving is started by pressing . The symbol flashes until the programmed measurement series is accepted.



Cancel saving procedure.

Starts automatic saving again. An additional measurement series is added.



# Memory settings

## Reading or printing memory

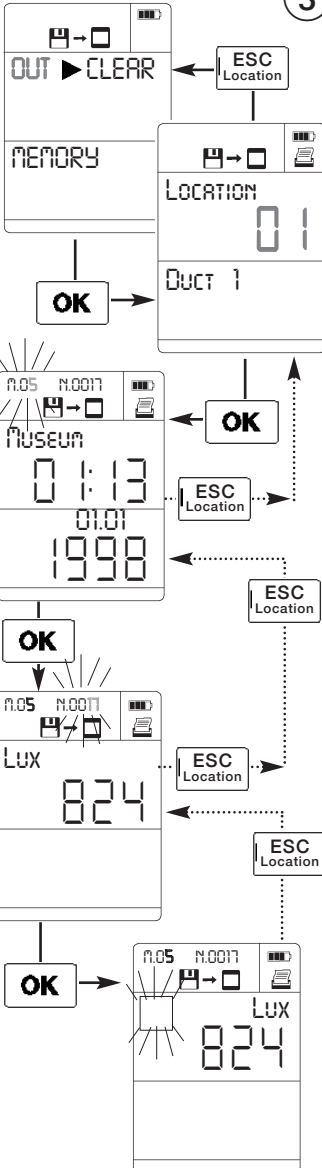

Press the **OK** button to access the memory settings mode. Confirm flashing save symbol  via the  button.  
Cancel printout by pressing the  button.

3







OUT

### 1. Reading out or printing memory contents:

If the “OUT” display is flashing and the  button is pressed, printing of the complete memory contents is started. Cancel printout by pressing the  button.

### 2. Selecting the location:

If **OK** is activated selection options appear in the display to select the required location. Select location by pressing  .

If printing is activated by pressing  at this point, **all** of the logs (measurement series and cycles) for this location are printed. Cancel printout by pressing the  button.

### 3. Selecting the log:

Confirm the location selected above by pressing **OK**. The M.Ox counter flashes in the display.

Select the log no. by pressing  .

 activates a printout of the selected measurement log. Press **OK** to display the values measured.

Cancel printout by pressing the  button.

### 4. Select the measurement cycle (only possible if a measurement log consists of a measurement series):

Confirm the measurement log selected above by pressing **OK**. The N.Ox counter flashes in the display.

Select the measurement cycle by pressing  .

 activates a printout of the selected measurement cycle.

The  button enables you to go back one step.

# Memory settings

## Clearing memory contents/Sample printouts

Press the **OK** button to access the memory settings mode. Confirm flashing save symbol via the **SAVE** button.

### 4 CLEAR Clearing memory:

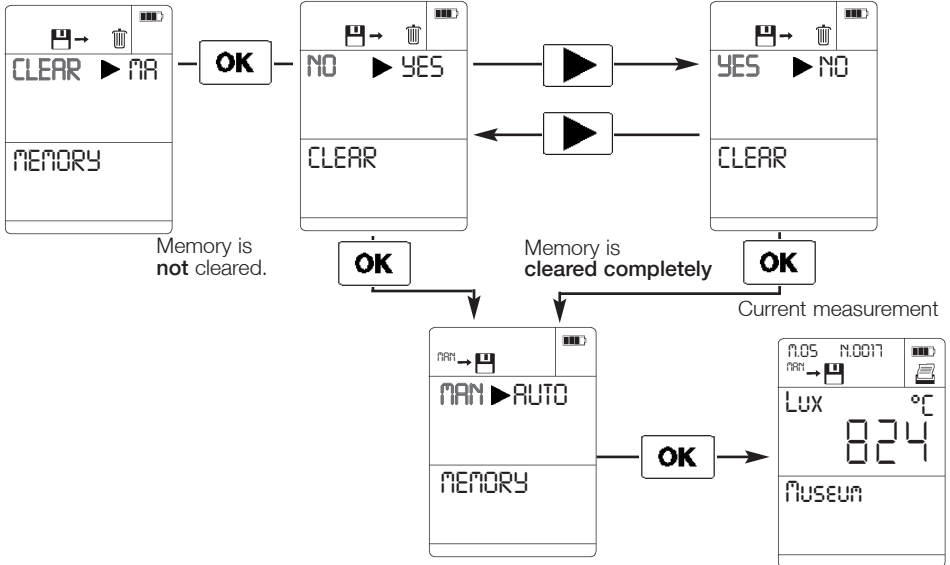

### Printout of automatic saving

Heading	SMITH LTD.
Date of printout	31.08.1998 11:27:32
Location	MUSEUM
Log	M.05
Start of saving	31.08.1998 11:26:59
Measuring cycle	cycle 00:00:02

----- 1: Lux -----	
01	653
02	652
03	650
04	690
05	705
06	710
07	695
08	675
09	638
INFO :	

### Printout of manual saving

```

SMITH LTD.
31.08.1998 11:26:05
MUSEUM

M.01
31.08.1998 11:20:05

1:      725    Lux



INFO :
```



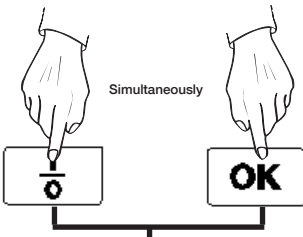

# Instrument configuration

## Power save function / Power supply



The  button enables you to change to the current measurement from every menu item.

The  button has to be kept pressed for approx. 2 seconds when switching on the instrument ( button).

The blinking position can be changed by pressing    or confirmed by pressing .

**Power save function**  
Auto OFF function is switched on ("ON")

If a button has not been pressed in the last 5 minutes or there is no communication with the PC, the instrument switches off automatically.

### Exceptions:

- the function is deactivated during timed and multi-point mean calculation
- Automatic saving mode:  
The function is only activated if saving cycles > 1 min are programmed.
- In the case of an activated function (cycle >1 min) the instrument switches itself on at the measurement time and switches off again. This also occurs if the instrument is switched off via the  button after the saving program has been activated.

**BAT: Battery operation** with 9 V block battery, Alkali manganese IEC 6LR61.

**AKKU: Rechargeable battery operation** with Testo rechargeable battery (Part no. 0515.0025), Type: Ni-MH IEC 6F22. If the **rechargeable battery** is empty: Recharge battery in external charger (Part no. 0554.0025).

### Note:

If the battery/rechargeable battery is removed, the instrument retains set values (date/time) and memory contents for approx. 10 minutes. The data is lost after 10 minutes. The capacity of the battery/rechargeable battery is shown in the display:



100 %

75 %

50 %

25 %

(last segment is flashing: the battery/rechargeable battery is almost empty)



0 %

(change battery/recharge rechargeable battery). Instrument switches off after 1 min.

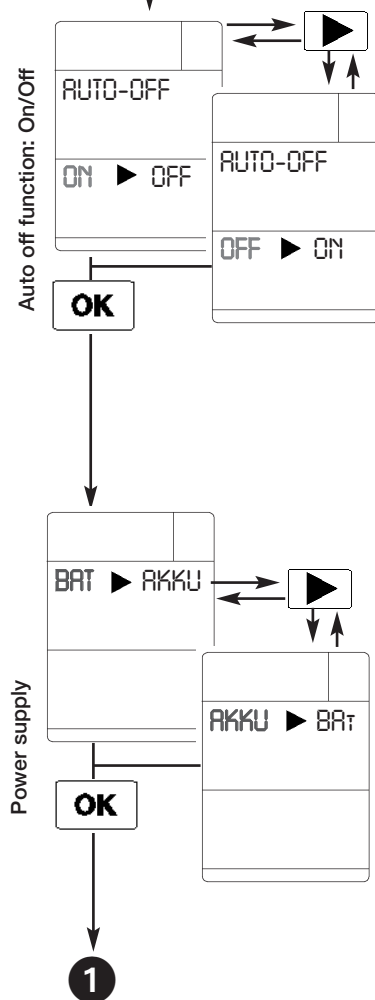

# Instrument configuration

Unit selection / Factory reset / Power supply

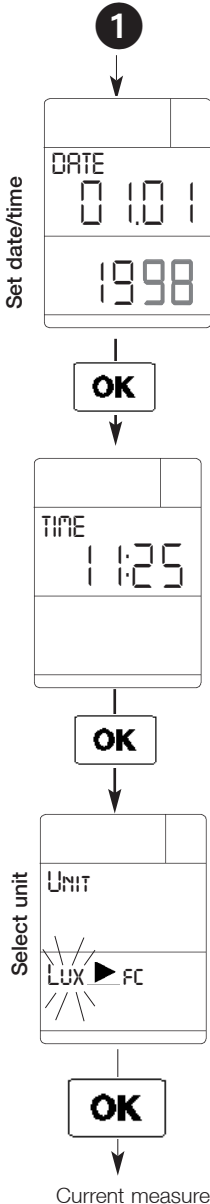

## Setting date

The flashing position in the display can be set

- / = scroll / = next position -

## Setting the time

The blinking position in the display can be set

- / = scroll / = next position -

LUX FC

The selected parameter flashes.

→ Select

confirms the selection.

Factory resets all of the settings in the instrument configuration to the factory settings.



- "AUTO OFF" is set at "ON"

- "Lux" is activated

confirms the selection and switches to the display of the current measurement.

## Error messages

---

Error message	Cause	Remedy
Memory full	The memory is full	Clear memory
	Measuring range has not been reached	The measured values are outside the allowed measuring range. Switch resolution.
	Connection to the probe has been interrupted.	Please contact a Testo service point.

<b>Sensor:</b>	Silicon photodiode
<b>Meas. range:</b>	0 to 100,000 Lux
<b>Accuracy:</b>	To DIN EN 13032-1 f1 = 6 % f1 = V (I) adaptation f2 = 5 % f2 = cos like rating
<b>Resolution can be switched:</b>	0 to 32,000 Lux 1 Lux 0 to 100,000 Lux 10 Lux  0 to 3.200 fc 0,1 fc 0 to 10.000 fc 1 fc
<b>Display:</b>	2 line LCD and 2 matrix lines
<b>Battery lifetime:</b>	9 V IEC 6F22 > 50 h Al-Mn
<b>Battery check:</b>	Automatically in 4 stages
<b>Operating temperature:</b>	0 to +50 °C
<b>Storage temperature:</b>	-20 to +70 °C
<b>Dimensions:</b>	220 x 68 x 50 (instrument)
<b>Weight:</b>	500 g (incl. packaging)
<b>Warranty:</b>	Instrument: 2 years Probes: 12 months

### Ordering data for testo 545

#### Measuring instrument and accessories

Part no.

#### **testo 545**

**0560.0545**

incl. probe, batteries and instruction manual **and calibration protocol**

---

#### **TopSafe (indestructible protective case)**

**0516.0441**

**With bench stand and belt clip**, protects measuring instrument from impact, dirt...

---

#### **Testo log printer, with 4 AA batteries and 1 roll of thermal paper**

**0554.0547**

Prints measured data, location with date and time

---

#### **ComSoft 3 “Professional” with data management**

**0554.0830**

incl. data base, analysis and graphics function, data analysis, trend curve

---

#### **Transport case**

**0516.0445**

For safe storage of measuring instrument, TopSafe, probe and Testo log printer

---

#### **RS232 cable**

**0409.0178**

Connects measuring instrument ↔ PC for data transmission

---

#### **ISO calibration certificate**

**0520.0010**

Calibration point: 1000 Lux

---

