

# **PH SD Card Datalogger**

850060

Instruction Manual

**PH SD Card Datalogger 850060**

**Copyright ©2010** by Sper Scientific

ALL RIGHTS RESERVED

Printed in the USA

*The contents of this manual may not be reproduced or transmitted in any form or by any means electronic, mechanical, or other means that do not yet exist or may be developed, including photocopying, recording, or any information storage and retrieval system without the express permission from Sper Scientific.*

## TABLE OF CONTENTS

INTRODUCTION.....	5
FEATURES .....	6
MATERIALS SUPPLIED.....	7
POWER SUPPLY.....	8
METER COMPONENTS .....	9
KEYPAD.....	11
SETUP.....	12
CALIBRATION.....	19
MEASUREMENT PROCEDURES..	23
DATALOGGER.....	31
BATTERY REPLACEMENT .....	36
MAINTENANCE .....	37
TROUBLESHOOTING.....	41
PC CONNECTION.....	42
OPTIONAL ACCESSORIES.....	47

## TABLE OF CONTENTS

SPECIFICATIONS .....	49
WARRANTY .....	52

## INTRODUCTION

The Sper Scientific PH SD Card Datalogger (Model 850060) is an intelligent meter that reads pH and mV.

This meter has a wide variety of applications in industries such as water conditioning, aquariums, fish hatcheries, food processing, photography, laboratory, paper, plating, quality control, and science education.

This meter features a real time SD memory card datalogger. Standard, portable SD memory cards provide unlimited data storage and upload pre-formatted data directly to Excel, eliminating the need for cables or software. Alternatively, manually record 99 readings for on-screen review or stream data directly to a computer using the optional software and cables. Each data set includes pH or mV measurement, time and date.

## **FEATURES**

- Reads pH and mV
- Automatic or manual temperature compensation for pH measurement
- SD memory card datalogger
- Manual datalogger option
- Highly accurate microcomputer circuit
- RS232 or USB PC connection
- Direct upload of data to Excel
- Internal clock and calendar
- Touch-tone
- Tripod mounting screw
- Built-in tabletop stand
- Maximum and minimum
- Hold function
- Auto-power-off
- Low battery indicator
- Backlight

## **MATERIALS SUPPLIED**

- Meter
- SD Card
- 6 AA Batteries
- Instruction Manual
- Soft Carrying Case

## POWER SUPPLY

This meter can be powered by six AA (1.5 V, UM3) batteries or an optional 9 Volt DC adapter. See page 36 for battery replacement instructions.

Plug the adaptor into the power port labeled "DC 9V," located on the side of the meter (under the protective black cover).

### **Note...**

When using the adapter, the meter will remain permanently **on** and the **POWER** button will be disabled.



## METER COMPONENTS

### Top of Meter



### Bottom of Meter

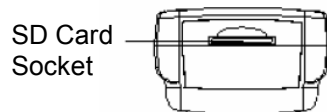

### Side of Meter

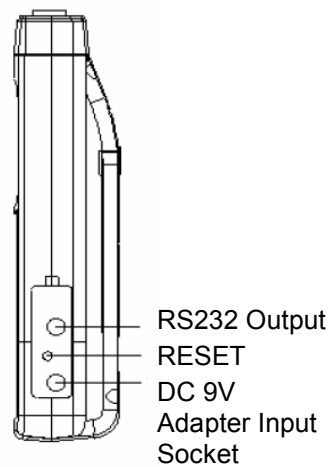

## METER COMPONENTS

### Back of Meter

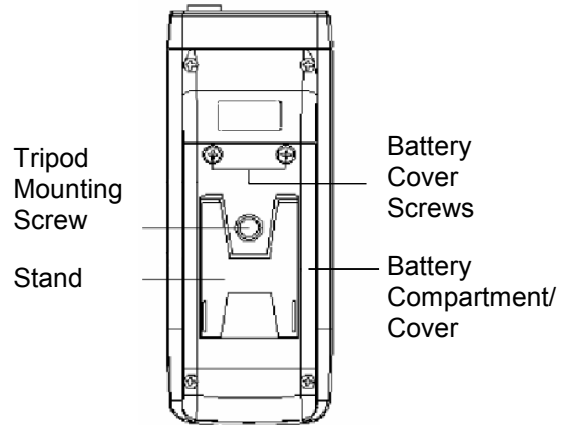

## KEYPAD

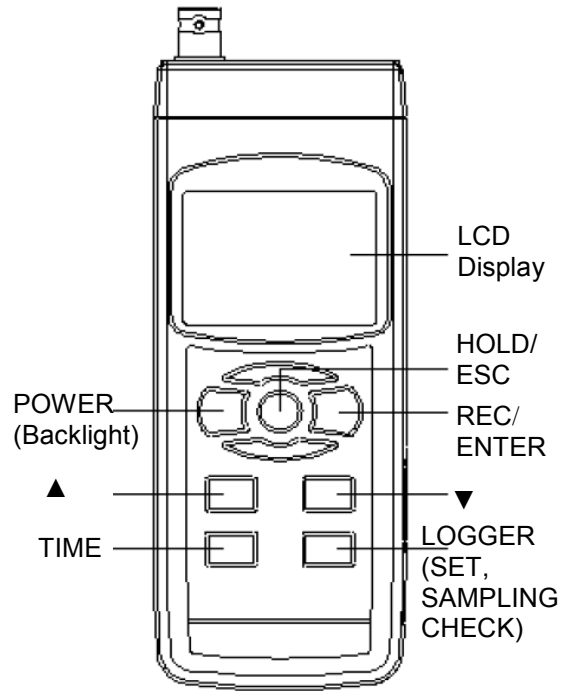

## SETUP MODE

The advanced Setup Mode allows you to customize the following meter preferences and defaults:

- SD Memory Card Format
- Real Time Clock
- Sampling Time
- Auto Power Off
- Touch-Tone
- Decimal Type
- Temperature Units
- Manual Temperature Compensation Value

### **Note...**

The setup functions can be performed under any parameter but not while utilizing the datalogger function. Once selections are saved, the meter will default to the selected preferences.

- 12 -

[www.ponpe.com](http://www.ponpe.com)

## SETUP MODE

1. Press **POWER** to turn the meter **on**.
2. Press **SET** for 2 seconds or longer to enter Setup Mode.
3. Press **SET** to cycle through the setup functions.

### **Note...**

Press **ESC** to exit Setup Mode. The meter will return to Normal Mode.

### **SD Memory Card Format**

Enabling this function will format the SD memory card to work specifically with your meter. Formatting the SD card will erase any previous memory on the card. New SD cards should be formatted to work with your meter.

1. Enter the SD memory card format function from Setup Mode (see page 13). "Sd F" appears on the LCD.

## SETUP MODE

2. Press ▲ or ▼ to select yes (format the SD memory card) or no (do not format the SD memory card). Press **ENTER** to confirm your selection. If selecting yes, “yES Enter” will appear on the LCD, press **ENTER** again and the meter will format the SD card.

### Real Time Clock

1. Enter the clock function from Setup Mode (see page 13). “dAtE” appears on the LCD.
2. Press **ENTER**. The year will flash on the LCD.
3. Press ▲ or ▼ to adjust the value. Press **ENTER** to save the value.
4. Repeat Step 3 to adjust the month, date, hour, minute and second.
5. Press **SET** to complete the clock setup function.

## SETUP MODE

### Note...

This procedure adjusts the meter's internal clock. The internal clock will function when the meter is turned **off** but only when the batteries have adequate power (not with low battery power.)

### Sampling Time

The sampling time (hour/minute/second) is the time allotted between successive measurements. To adjust the sampling time:

1. Enter the sampling time function from Setup Mode (see page 13). "SP-t" appears on the LCD.
2. Press ▲ or ▼ to adjust the value (starting with the hour value). Press **ENTER** to save the value. The meter will advance to the next value adjustment (minute, second).
3. Repeat Step 2 until the setting is complete.

## SETUP MODE

4. Press **SET** to save the value.

### Auto Power Off

The meter automatically turns **off** after 10 minutes of inactivity, however this function can be disabled.

1. Enter the auto power off function from Setup Mode (see page 13). "PoFF" appears on the LCD.
2. Press **▲** or **▼** to select yes (auto power off enabled) or no (auto power off disabled). Press **ENTER** to save the selection.

### Touch-Tone

1. Enter the touch-tone function from Setup Mode (see page 13). "bEEP" appears on the LCD.
2. Press **▲** or **▼** to select yes (touch-tone enabled) or no (touch-tone disabled). Press **ENTER** to save the selection.



## SETUP MODE

### Decimal Type

Although the decimal is commonly expressed as the “.” symbol (i.e., 20.6 or 1000.53), some (European) countries use a “,” symbol to represent the decimal (i.e., 20,6 or 1000,53). The meter defaults to the period symbol. To adjust:

1. Enter the decimal type function from Setup Mode (see page 13). “dEC” appears on the LCD.
2. Press ▲ or ▼ to select Basic (.) or Euro (,). Press **ENTER** to save the selection.

### Temperature Units

1. Enter the temperature units function from Setup Mode (see page 13). “t-CF” appears on the LCD.
2. Press ▲ or ▼ to select C (degrees Celcius) or F (degrees Fahrenheit). Press **ENTER** to

## SETUP MODE

save the selection.

### **Manual Temperature Compensation Value (pH only)**

1. Enter the manual temperature compensation function from Setup Mode (see page 13). "t-SEt" appears on the LCD.
2. Press ▲ or ▼ to adjust the value to the desired selection (in °C or °F). Press **ENTER** to save the selection.

#### **Note...**

After completing this function, press **SET** to advance to the next function. "ESC" appears on the LCD. Press **ESC** to complete the setup procedures and return to Normal Mode.

## CALIBRATION

This meter has been calibrated using a pH probe with an ideal reading: generates 0 mV at pH 7.00 (177.4 mV at pH 4) in an ambient temperature of 25°C. Because your probe may not be ideal, calibration is necessary before first time use. For best results, calibrate your meter weekly. For the highest accuracy, we recommend a two point calibration. Begin with pH 7 (then calibrate pH 4 or 10).

To calibrate:

1. Prepare the probe for calibration (see page 25).
2. Using a standard pH and/or ATC probe, plug the probe plug into the pH probe socket.
3. Press **POWER** to turn the meter **on**.
4. For the standard pH probe only (not ATC): Adjust the manual temperature compensation value

## CALIBRATION

to the same value as the solution temperature. (See page 18.)

5. Select the pH buffer and pour solution (a sufficient amount to totally immerse the probe tip) into a clean container.
6. Dip the probe into the container, immersing the probe tip. Gently shake the probe.

### Note...

If calibrating the ATC probe with the pH probe, dip the probes in the solution simultaneously.

7. The pH value appears on the LCD.
8. Press **REC** and **HOLD** simultaneously until "PH" appears on the display.

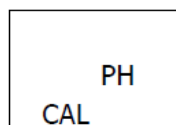

- 20 -

[www.ponpe.com](http://www.ponpe.com)

## CALIBRATION

9. Press ▲ or ▼ in sequence to select the following screens:

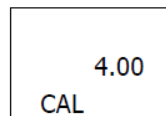

pH 4.00  
calibration

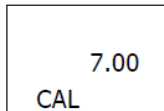

pH 7.00  
calibration

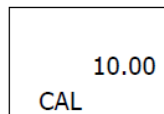

pH 10.00  
calibration

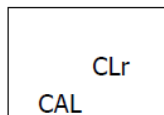

Clear the  
existing  
calibration data

10. When the desired screen is reached (pH 7 for the first calibration point), press **ENTER** to save the calibration data and complete the procedure.

### Note...

To clear the existing calibration data, press **ENTER** when the "CLr" screen

## **CALIBRATION**

appears on the LCD.

11. Repeat the calibration procedure for pH 4 or pH 10, using the corresponding buffer solution.
12. Repeat the entire procedure for the two calibration points at least twice.

## MEASUREMENT PROCEDURES

### Turning the Unit On/Off

1. Press **POWER** to turn the meter **on**.
2. Press and hold **POWER** for 2 seconds to turn the meter **off**.

### Selecting the Function

1. Press and hold **FUNC** to cycle through the options listed below. Release **FUNC** when you reach the desired function.
  - pH  
“pH” appears on the LCD.
  - mV  
“mV” appears on the LCD.

### Defaults

The meter will default to the following settings:

## MEASUREMENT PROCEDURES

- pH
- °C
- Manual ATC (without connecting the ATC probe)
- Auto power off
- Datalogger sampling time: 2 seconds

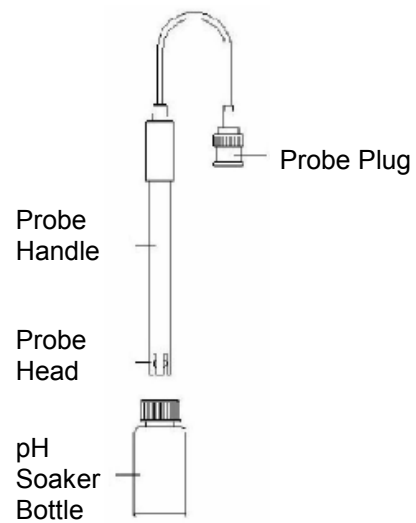

- 24 -



## MEASUREMENT PROCEDURES

### Preparing the pH/ORP Probe

1. Remove the pH or ORP probe soaker bottle by rotating the bottle and cap and slide the bottle and cap off the probe.
2. Rinse the probe tip with de-ionized or distilled water before use.

#### **Note...**

If the probe tip is dehydrated, soak it for 30 minutes in a KCl solution. **DO NOT** wipe the pH probe dry. Wiping the probe may cause static and cause measurement instability.

### pH Measurement with Manual Temperature Compensation

1. Press **POWER** to turn the meter **on**.
2. Using a pH probe, plug the probe plug into the pH probe socket.
3. Adjust the manual temperature

- 25 -

## **MEASUREMENT PROCEDURES**

compensation value to the same value as the solution temperature. (See page 18.)

3. Select the pH buffer and pour solution (a sufficient amount to totally immerse the probe tip) into a clean container.
4. Dip the probe into the container, immersing the probe tip. Gently shake the probe.
5. The pH value appears on the upper display of the LCD. The manual temperature compensation value appears on the lower display.

### **pH Measurement with Automatic Temperature Compensation (ATC)**

This meter is designed to take readings with automatic or manual temperature compensation. Automatic temperature compensation only occurs when a temperature probe is plugged into the meter.

- 26 -

## **MEASUREMENT PROCEDURES**

1. Press **POWER** to turn the meter **on**.
2. Using a pH probe, plug the probe plug into the pH probe socket.
3. Using a temperature (ATC) probe, plug the probe plug into the temperature probe socket.
4. Select the pH buffer and pour solution (a sufficient amount to totally immerse the probe tip) into a clean container.
5. Dip both probes into the container, immersing the probe tips. Gently shake the probes.
6. The pH value appears on the upper display of the LCD. The solution's temperature value (measured by the ATC probe) appears on the lower display.

### **mV Measurement**

This meter has a built-in mV (millivolt)

- 27 -

[www.ponpe.com](http://www.ponpe.com)

## MEASUREMENT PROCEDURES

measurement function, which allows for ion-selective, ORP (oxidation-reduction potential) and other precise mV measurements.

1. Press **POWER** to turn the meter **on**.
2. Press **FUNCTION**. “mV” appears on the LCD.
3. Using an ORP probe, plug the probe plug into the pH probe socket.
4. The mV value appears on the LCD.

### Hold Function

1. Press **HOLD** to freeze the reading on the display. “HOLD” will appear on the LCD.
2. Press **HOLD** again to release the hold function. “HOLD” will disappear from the LCD.

## MEASUREMENT PROCEDURES

### Maximum and Minimum

To record maximum and minimum readings:

1. Press **REC** to begin recording the maximum and minimum values. "REC" appears on the LCD.
2. Press **REC**. The maximum value and "REC MAX" will appear on the LCD.
3. Press **REC**. The minimum value and "REC MIN" will appear on the LCD.
4. To delete the maximum or minimum value, press **HOLD**. "REC" appears on the LCD and the meter will begin recording the maximum and minimum values again.
5. To exit the min/max function, press and hold **REC** for 2 seconds. The meter will return to Normal Mode.

- 29 -

## MEASUREMENT PROCEDURES

### Backlight

1. The backlight turns on automatically when the meter is turned **on**.
2. Press  to turn the backlight off or on.

### View Real Time Clock

To view the time function during normal measurement (not during datalogging):

1. Press **TIME**. The time information (hour, minute, second) will appear on the lower display of the LCD.

### View Sampling Time

To view the sampling time function during normal measurement (not during datalogging):

1. Press **SAMPLING CHECK**. The sampling time (in seconds) will appear on the lower display of the LCD.

## DATALOGGER

### Preparing the Datalogger

1. Insert the SD card into the SD card socket on the bottom of the meter, ensuring that the front of the SD card faces the back of the meter.
2. Format the SD card as needed (see page 13).
3. Set the clock if using the meter for the first time (see page 14).
4. Set the decimal type if using the meter for the first time (see page 17.)

### Auto Datalogging

1. Set the sampling time to  $\geq 1$  second. Refer to page 15.
2. Press **REC**. "REC will appear on the LCD.

## DATALOGGER

3. Press **LOGGER**.  
“DATALOGGER” will flash on the LCD and the alarm will sound while the measurement data and time information are saved to memory.
4. To pause datalogging, press **LOGGER**. The meter will temporarily stop recording and “DATALOGGER” will stop flashing on the LCD. Press **LOGGER** again to resume datalogging. “DATALOGGER” will flash on the LCD.
5. To finish datalogging, pause the datalogger. Press **REC** for 2 seconds or longer. “REC” will disappear from the LCD to indicate that datalogging has ended.

### **Note...**

To enable/disable the touch-tone feature, see page 16.



# DATALOGGER

## Manual Datalogging

1. Set the sampling time to 0 seconds. Refer to page 15.
2. Press **REC**. "REC" will appear on the LCD.
3. Press **LOGGER**.  
"DATALOGGER" will flash on the LCD and the alarm will sound while the measurement data and time information are saved to memory. The position (location) number will appear on the bottom of the LCD and will also be recorded on the SD card.

### Note...

To enable/disable the touch-tone feature, see page 16. Press ▲ or ▼ to set the position number (from 1 to 99). To indicate the position location, P x (x = 1 to 99) will appear on the lower display.

4. To finish datalogging, press **REC**

## **DATALOGGER**

for longer than 2 seconds. "REC" will disappear from the LCD to indicate that datalogging has ended.

### **SD Card Data Structure**

1. The first time a SD card is used in this meter, a folder PHA01 will be generated.
2. If the datalogger is being used for the first time, a new file PHA01001.XLS will be generated under the route PHA01\. After exiting the datalogger and executing the function again, the data is saved to the PHA01001.XLS file until the data reach 30,000 data columns. A new file will then be generated (i.e., PHA01002.XLS).
3. The folder PHA01\ will hold 99 files. A new route (i.e., PHA02\) will be generated when exceeding 99 files.

## DATALOGGER

4. The file's route structure:

```
PHA01\  
    PHA01001.XLS  
    PHA01002.XLS  
    .....  
    PHA01099.XLS  
PHA02\  
    PHA02001.XLS  
    PHA02002.XLS  
    .....  
    PHA02099.XLS  
PHAXX\  
    .....  
    .....
```

**Note...**

XX: Maximum value is 10.

## BATTERY REPLACEMENT

This meter uses six AA (1.5 V, UM3) batteries. When the low battery indicator  appears on the LCD, battery replacement is needed. After the icon appears on the LCD, in-spec measurement can still be made for several hours before becoming inaccurate.

1. Press and hold **POWER** for 2 seconds to turn the meter **off**.
2. Unscrew the battery cover and remove from the meter.
3. Remove the old batteries and replace with six new AA batteries, ensuring correct polarity.
4. Replace the battery cover. Tighten the screws on the battery cover to secure to the meter.

## MAINTENANCE

### pH Probe

It is important to keep the pH probe wet when not in use. The probe is protected by a plastic bottle containing solution. To use or store the probe:

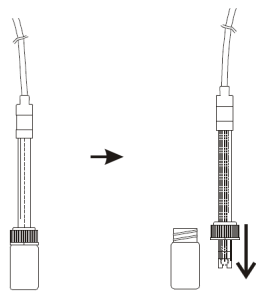

1. Rotate the bottle to remove the bottle from the probe. Pull down the cover and remove it from the probe.
2. After use, put the cover back on the probe and plug the probe into the bottle. Rotate the bottle to fit into the cover tightly.

## **MAINTENANCE**

The following actions will keep the probe in good working condition:

- Always keep the pH glass bulb wet by using the plastic bottle to protect and store the probe. You can also store it in a KCl solution. Never use distilled or de-ionized water for storage.
- Always rinse the pH probe in de-ionized water before using.
- Never touch or rub the glass bulb tip.

### **ORP Probe**

Before using, remove the soaking bottle, soak the probe in distilled water, and rinse. Gently dry the sensing element.

### **ORP Probe Cleaning**

A contaminated sensing element can result in a slow response and/or

## MAINTENANCE

inaccurate reading.

- If the contamination is mineral matter, put the sensing element in a 0.1 N HCl solution for 10 minutes. Rinse in distilled water.
- If the contamination is oil or grease, clean with a mild detergent. Rinse in distilled water.

Upon completion of either cleaning method, immerse the probe in a saturated buffer solution with pH 4.01 for 15 minutes and rinse with distilled water. After cleaning, soak the probe in solution for at least 8 hours.

### **Probe Performance**

The sensing element of an ORP probe is made of a high purity metal. Soaking the sensing element in a solution for a long period of time may cause slow response time and inaccurate readings. An oxidation reduction coating may have formed on the surface of the sensing

## **MAINTENANCE**

element. Resolve by cleaning the element.

When measuring a solution with a low concentration of oxidation reduction matter and slow ion exchange rate, a slow response time and inaccurate readings may occur. Under these conditions, it may take 8-24 hours to obtain an accurate reading.



## TROUBLESHOOTING

### System Reset

If the meter is not functioning properly (i.e., the system is frozen and the keypad is non-operational), reset the meter:

1. Press **POWER** to turn the meter **on**.
2. Use a small tool (such as a disassembled paperclip or a pin) to press the **RESET** button (located on the right side of the meter under the protective black cover). Wait a few seconds for the meter to restart.

## PC CONNECTION

To save data from the SD card to a PC (using Excel software):

1. After datalogging is complete, remove the SD card from the meter's SD card socket.
2. Insert the SD card into the computer's SD card slot (if built into the computer) or into a SD card adapter (ensuring that the adapter is connected to the computer).
3. Turn the computer **on** and run the Excel program.
4. Download the saved data file (i.e., PHA01001.XLS, PHA01002.XLS) from the SD card to the computer. The data will appear in the Excel software screen and can then be used in Excel to create graphs, etc.

# PC CONNECTION

## Excel Data Screen

	A	B	C	D	E	F	G
1	Position	Date	Time	Ch1_Value	Ch1_Unit	Ch2_Value	Ch2_unit
2	1	2009/8/12	13:26:37	7.00	ph	25.0	Degree_C
3	2	2009/8/12	13:26:39	7.01	ph	25.0	Degree_C
4	3	2009/8/12	13:26:41	7.01	ph	25.0	Degree_C
5	4	2009/8/12	13:26:43	7.00	ph	25.0	Degree_C
6	5	2009/8/12	13:26:45	7.00	ph	25.0	Degree_C
7	6	2009/8/12	13:26:47	7.00	ph	25.0	Degree_C
8	7	2009/8/12	13:26:49	7.00	ph	25.0	Degree_C
9	8	2009/8/12	13:26:51	6.99	ph	25.0	Degree_C
10	9	2009/8/12	13:26:53	6.98	ph	25.0	Degree_C
11	10	2009/8/12	13:26:55	6.99	ph	25.0	Degree_C
12	11	2009/8/12	13:26:57	6.99	ph	25.0	Degree_C
13	12	2009/8/12	13:26:59	7.00	ph	25.0	Degree_C

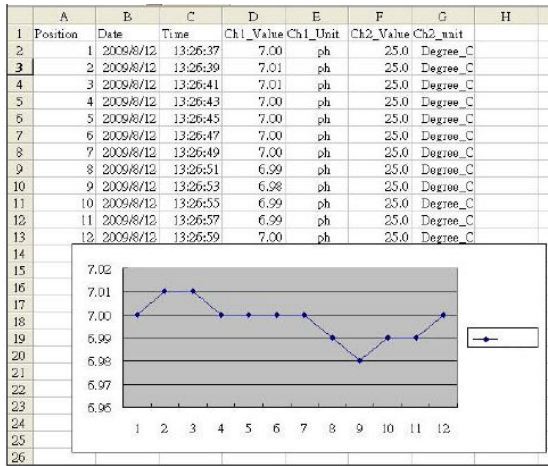

## PC CONNECTION

### Excel Graphic Screen

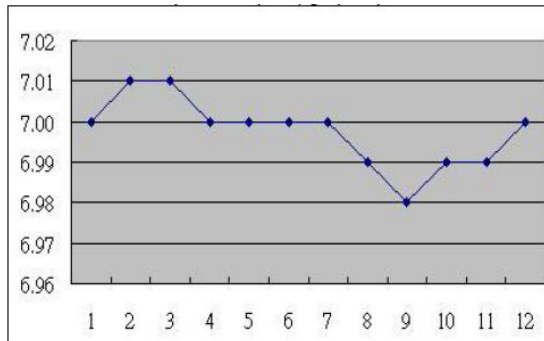

### RS232 PC Serial Interface

This meter has a RS232 PC serial interface via a 3.5 mm terminal.

The data output is a 16 digit stream that can be utilized for the user's specific application.

A RS232 lead with the following connection will be required to link the meter with the PC serial port:

## PC CONNECTION

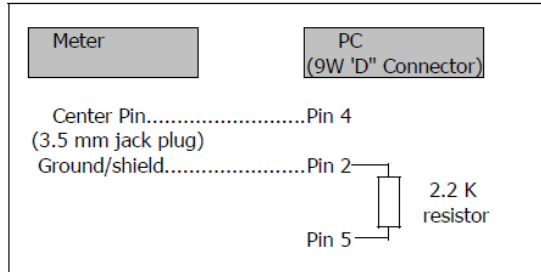

The 16 digit data stream will display in the following format:

D15 D14 D13 D12 D11 D10 D9 D8  
D7 D6 D5 D4 D3 D2 D1 D0

Each digit indicates the following status:

D15	Start word
D14	4
D13	When send the upper display data = 1 When send the lower display data = 2

## PC CONNECTION

D12 & D11	Annunciator for Display		
	pH = 05	mV = 18	
D10	Polarity, 0 = Positive, 1 = Negative		
D9	Decimal point (DP) position from right to left 0 = No DP, 1 = 1 DP, 2 = 2 DP, 3 = 3DP		
D8 to D1	Display reading, D1 = LSD, D8 = MSD For example: If the display reading is 1234, then D8 to D1 is 00001234		
D0	End word		

RS232 Format: 9600, N, 8, 1

Baud rate	9600
Parity	No parity
Data bit no.	8 Data bits
Stop bit	1 Stop bit

## OPTIONAL ACCESSORIES

- 840016 pH Probe (non-ATC)
- 840038 ATC Temperature Probe
- 840049 Spear Tip pH Probe  
(non-ATC)
- 840057 RS232 Computer  
Cable
- 840059 2GB SD Card
- 840090 Water Resistant  
Instrument Pouch
- 840093 Field Tripod
- 840094 USB Computer Cable
- 840097 AC Adaptor
- 850080 Software
- 850088 ORP Probe
- 860008 pH4, 3 bottles, 40mL  
each

## OPTIONAL ACCESSORIES

- 860009 pH7, 3 bottles, 40mL  
each
- 860010 pH10, 3 bottles, 40mL  
each
- 860011 De-ionized Water, 3  
bottles, 40mL each



## SPECIFICATIONS

### General

<b>Circuit</b>	Custom one-chip of microprocessor LSI circuit
<b>Display</b>	LCD size: 52 mm x 38 mm Backlight function
<b>Measurement Unit</b>	pH ORP (mV)
<b>Sampling Time of Display</b>	Approximately 1 second
<b>Data Output</b>	RS232/USB PC computer interface
<b>Memory Card</b>	SD card 1 GB to 16 GB
<b>Operating Temperature</b>	0 ~ 50°C
<b>Operating Humidity</b>	< 85%RH
<b>Power Supply</b>	Alkaline or heavy duty DC 1.5 V battery (UM3, AA) x 6 pieces DC 9V adapter input (AC/DC power adapter is optional)

## SPECIFICATIONS

<b>Power Current</b>	Normal Operation (without use of the datalogger or backlight): Approximately DC 14 mA
	Datalogger Operation (backlight is off): Approximately DC 37 mA
	If the backlight is on, the power consumption will increase by approximately 12 mA.
<b>Dimensions</b>	177 x 68 x 45 mm 7 x 2 ¾ x 2"
<b>Weight</b>	489 g (1 lb)

The following specifications tests were performed in an ambient temperature of  $23 \pm 5^{\circ}\text{C}$ :

<b>pH Probe</b>	Optional, Any pH probe with BNC Connector	
<b>Measurement</b>	pH	0 ~ 14 pH
	mV	-1999 ~ 1999 mV
<b>Input Impedance</b>	$10^{12}$ ohm	

## SPECIFICATIONS

<b>Temperature Compensation for pH Measurement</b>	Manual	0 ~ 100°C, adjustable in Setup Mode
	Automatic (ATC)	0 ~ 65°C (with included ATC Probe - Model 840038)
<b>pH Calibration</b>	pH 7, pH 4, and pH 10, 3 point calibration ensures the best linearity and accuracy	

<b>Unit</b>	<b>Range</b>	<b>Resolution</b>	<b>Accuracy</b>
pH	0 ~ 14 pH	0.01 pH	± (0.02 pH + 2 d)
mV (ORP)	0 ~ 1999 mV	1 mV	± (0.5% + 2 d)

**Note...**

The pH accuracy applies to a calibrated meter only.

## WARRANTY

Sper Scientific warrants this product against defects in materials and workmanship for a period of five (5) years from the date of purchase, and agrees to repair or replace any defective unit without charge. If your model has since been discontinued, an equivalent Sper Scientific product will be substituted if available. This warranty does not cover probes, batteries, battery leakage, or damage resulting from accident, tampering, misuse, or abuse of the product. Opening the meter to expose its electronics will void the warranty. To obtain warranty service, ship the unit postage prepaid to:

SPER SCIENTIFIC LTD  
7720 E Redfield Rd, Suite 7  
Scottsdale, AZ 85260

The defective unit must be accompanied by a description of the problem and your return address. Register your product online at [www.sperscientific.com](http://www.sperscientific.com), or return your warranty card within 10 days of purchase.



Rev. 1/28/2011

- 52 -

[www.ponpe.com](http://www.ponpe.com)