

EL-USB-3



Voltage Data Logger

- 0 to 30V d.c. measurement range
- Stores over 32,000 readings
- Logging rates between 1 second and 12 hours
- Connection via two screw terminals
- Immediate and delayed logging start
- User-programmable alarm thresholds
- Status indication via red and green LEDs
- EasyLog software available as a free download



This standalone data logger measures and stores over 32,000 voltage readings over a 0 to 30V d.c. range at a resolution of 50mV d.c.

The user can easily set up the logger and view downloaded data by plugging the data logger into a PC's USB port and using the available free downloadable EasyLog software. Data can then be graphed, printed and exported to other applications.

The data logger is supplied complete with a lithium metal battery, which gives a one year's logging life. The data logger is also issued with a 0 to 30V d.c. cap and features a pair of screw terminals, a set of equitable measurement leads and then followed up with a set of durable crocodile clips.

EL-WIN-USB

Lascar's EasyLog control software is available as a free download from www.easylogusb.com. Easy to install and use, the control software is compatible with 32-bit and 64-bit versions of Windows XP, Vista, 7 & 8. The software is used to set up the logger, download, graph and annotate data or export in Excel, PDF and jpeg formats.

The software allows the following parameters to be configured:

- Logger name
- Logging rate (customisable between 1 second and 12 hours)
- High and low alarms
- Immediate and delayed logging start

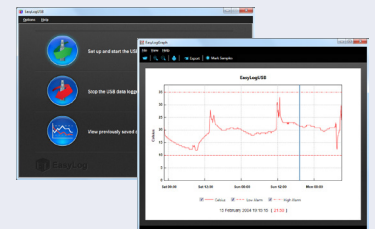

Download the latest version of the software free of charge from www.easylogusb.com

SPECIFICATIONS

Measurement range	0 to 30 V d.c.
Internal resolution	50 mV d.c.
Accuracy (overall error)	±1%
Logging rate	User selectable between 1 second & 12 hours
Operating temperature range	-35 to +80°C (-31 to +176°F)
Battery Life	1 Year
Readings	32,510
Dimensions	98 x 26.8 x 26.8 mm

ACCESSORIES

- BAT 3V6 1/2AA** Replacement battery
- USB-CAP-30V** Replacement Cap, 0 to 30V d.c. range

INCLUDED IN THE BOX

- BAT 3V6 1/2AA** Battery
- USB-CAP-30V** 0 to 2.4V d.c. Range Cap
- EL-USB-LEADS** Measurement Leads
- EL-USB WALL BRACKET** Mounting Bracket











EL-USB-3

Voltage Data Logger

LED STATUS INDICATION

The EL-USB-3 features two LEDs: a green/red LED to indicate logging and alarm status.

In normal operation the green LED will flash, but will change to red if an alarm condition has been triggered. Using EL-WIN-USB it is possible to set the alarm to remain active even if the reading has returned to normal, in which case the alarm LED will continue to flash red. This 'Hold' feature in the software ensures the user is notified that at some point an alarm level has been exceeded, without needing to download the data.

	Green single flash <i>(Every 10 Seconds)</i> The data logger is currently logging, no alarm.
	Green single flash <i>(Every 20 Seconds)</i> The data logger is currently logging. No alarm. Although, battery is low and should be replaced before logging important data.
	Green single flash <i>(Every 30 Seconds)</i> The data logger is not currently logging, but is primed to start at a later date and time. <i>(Delayed start)</i>
	Green double flash <i>(Every 20 Seconds)</i> The data logger is full and has stopped logging, no alarm.
	Red single flash <i>(Every 10 Seconds)</i> The data logger is currently logging. Low alarm.
	Red single flash <i>(Every 20 Seconds)</i> The data logger is currently logging. Low alarm. Although, battery is low and should be replaced before logging important data.
	Red double flash <i>(Every 10 Seconds)</i> The data logger is currently logging. High alarm.
	Red double flash <i>(Every 20 Seconds)</i> The data logger is currently logging. High alarm. Although, battery is low and should be replaced before logging important data.
	Red & green single flash <i>(Every 20 Seconds)</i> The data logger is full and has stopped logging. High, Low or both alarms.
	No LEDs flash The data logger is stopped, the battery is empty or there is no battery

CONNECION & APPLICATIONS

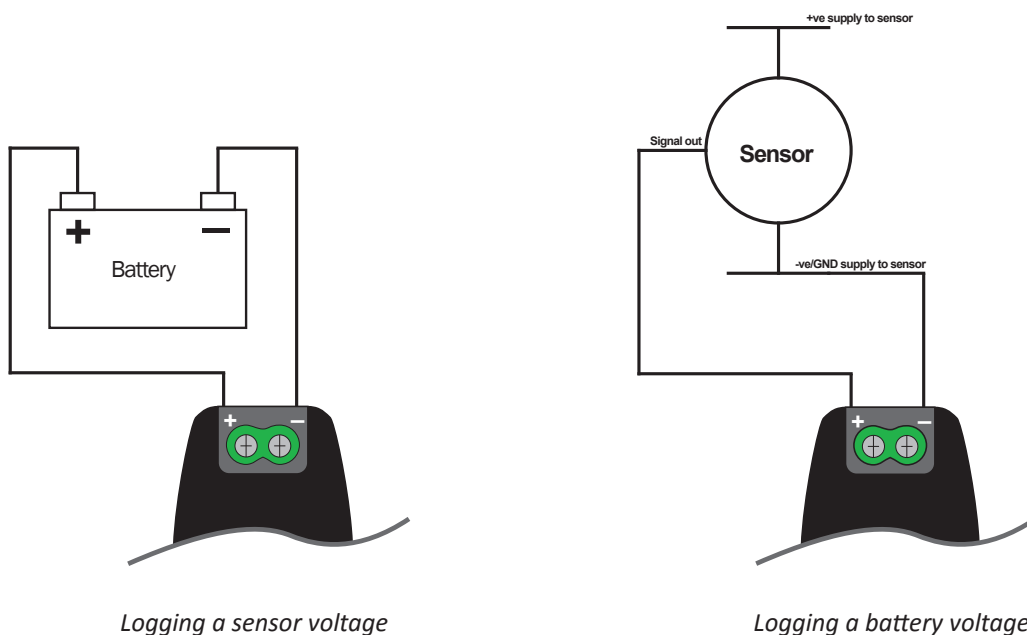

EL-USB-3

Voltage Data Logger

BATTERY INFORMATION

Replacement

We recommend that you replace the battery annually, or prior to logging critical data. Only use 3.6V ½AA lithium metal batteries. The data logger does not lose its stored readings when the battery is discharged or replaced; however, the data logging process will stop and will not resume until the battery is replaced and the logger restarted by EL-WIN-USB.

Before replacing the battery, remove the data logger from the PC. Please note that leaving the data logger plugged into the USB port for extended periods will cause some of the battery capacity to be lost.

Passivation

If left unused for extended periods of time, the lithium metal batteries used in the EasyLog range of data loggers naturally form a non-conductive internal layer, preventing them from self-discharge and effectively increasing their shelf life. When first installed in the data logger, this may cause a momentary drop in the battery voltage (the Transient Minimum Voltage) as the internal layer is broken down, resulting in the data logger resetting. Inserting the batteries in the data logger and leaving it connected to a PC for about 30 seconds will remove this layer. After this, remove and re-install the batteries to reset the data logger. Overall battery life will not be affected.

WARNING

Handle lithium metal batteries carefully, observe warnings on battery casing. Dispose of in accordance with local regulations.