

Instruction Manual

HI 931700 HI 932700

Panel - Mounted pH - ORP Indicators Controllers

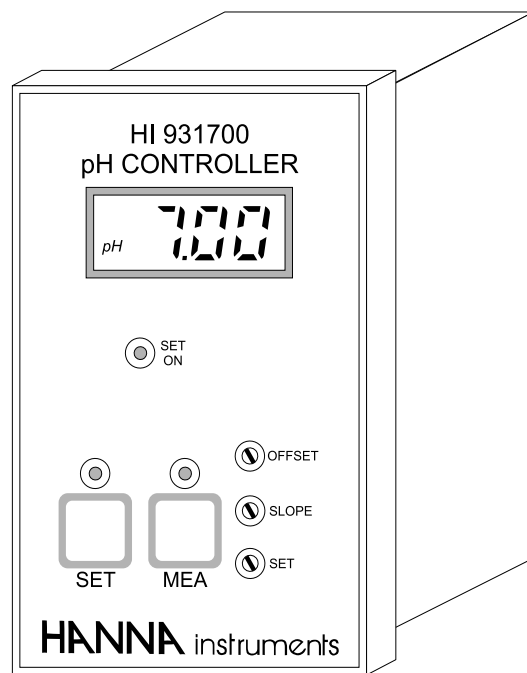

 **HANNA**
instruments
<http://www.hannainst.com>

These Instruments are in
Compliance with the CE Directives

Dear Customer,
Thank you for choosing a Hanna Instruments Product.

Please read this instruction manual carefully before using the instrument.

This manual will provide you with all the necessary information for the correct use of the instrument, as well as a precise idea of its versatility in a wide range of applications.

These instruments are in compliance with CE directives EN 50081-1 and 50082-1.

TABLE OF CONTENTS

Preliminary Examination	3
General Description	3
Functional Description HI 931700	5
Functional Description HI 932700	6
Mechanical Dimensions	8
Specifications HI 931700	9
Specifications HI 932700	9
Initial Preparation	10
Operational Guide	12
Calibration	13
Taking Redox Measurements	16
Electrode Conditioning and Maintenance ..	19
Temperature-Resistance Correlation for HANNA pH Sensitive Glass	24
Suggested Installations	26
Accessories	28
Warranty	34
CE Declaration of Conformity	35



PRELIMINARY EXAMINATION

Remove the instrument from the packing material and examine it carefully to make sure that no damage has occurred during shipping. If there is any noticeable damage, notify your Dealer.

Note: Save all packing materials until you are sure that the instrument functions correctly. All defective items must be returned in the original packing materials together with the supplied accessories.

GENERAL DESCRIPTION

HI 931700 and **HI 932700** respectively are pH and ORP panel-mounted indicators and controllers designed for simplicity of use in a wide range of industrial applications.

The models are panel mount designed with membrane keypads on the front panel and a 12x30 mm LCD display. Connections to the electrodes, power supply, contacts and recorders are made via the plug-in terminal blocks on the rear panel.

The instruments are equipped with a BNC socket and accept input direct from pH or ORP electrode.

Other features include: recorder output 0 to 20 mA or 4 to 20 mA as indicated; LED indicators which identify whether the controller is in operation mode or selection mode.

FUNCTIONAL DESCRIPTION HI 931700

FRONT PANEL

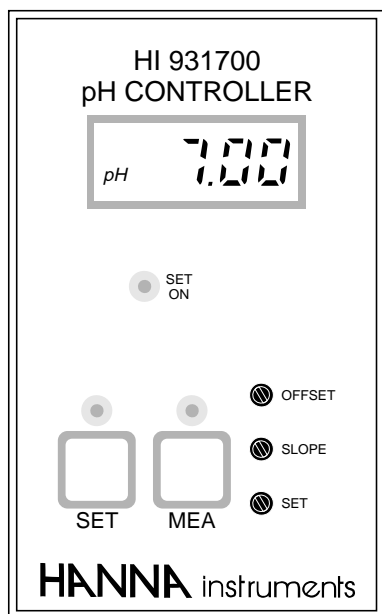

Keypad

- SET** To display and to set the working point of pH dosage
- MEASURE** To set HI 931700 to the measurement mode

Trimmers

- OFFSET** For Offset Calibration
- SLOPE** For Slope Calibration
- SET** To adjust the Set Point

Leds

- SET ON** To show that acidic or alkaline dosage is in progress

4

REAR PANEL HI 931700

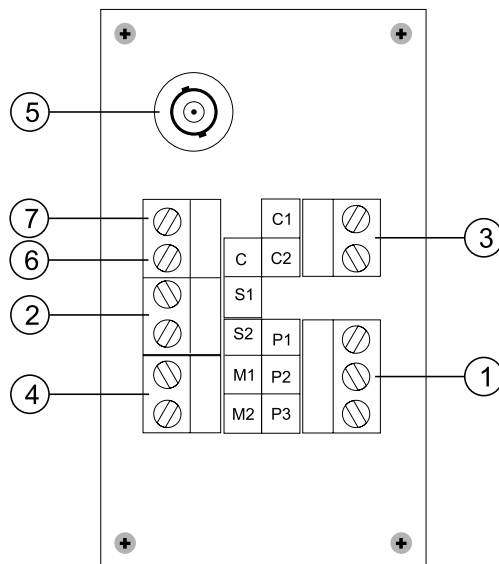

1. Power Supply

	15-24 VDC:	115 or 220 VAC:
P1	⇒ Not Connected	Earth
P2	⇒ Negative	Neutral
P3	⇒ Positive	Live
2. Acid/Base Dosage Selection (see page 10);
3. Connections for dosing pump to dose either acid or base products. These contacts act only as a switch for the power to the drive;
4. Recorder output (**M1** ⇒ + mA output, **M2** ⇒ - mA output);
5. BNC for pH electrode;
6. Connection for Potential Matching Pin;
7. Connection for Electrode Reference.

Note: Be sure your main line is protected by a fuse.

5

FUNCTIONAL DESCRIPTION HI 932700

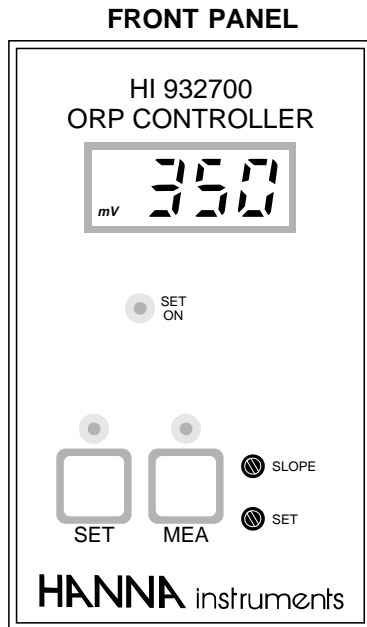

Keypad

SET To display and to set the working point of ORP dosage

MEASURE To set HI 932700 to the measurement mode

Trimmers

SLOPE For Slope Calibration

SET To adjust the Set Point

Leds

SET ON To show that oxidant or reductant dosage is in progress

REAR PANEL HI 932700

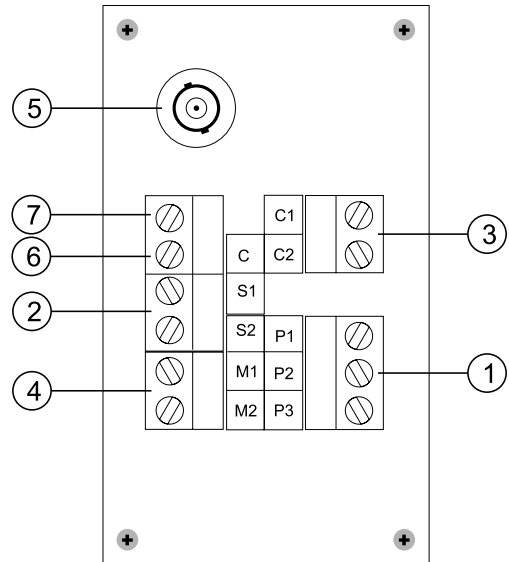

1. Power Supply

15-24 VDC:

115 or 220 VAC:

P1 ⇒ Not Connected

Earth

P2 ⇒ Negative

Neutral

P3 ⇒ Positive

Live

2. Oxidant/Reductant dosage selection (see page 10);

3. Connections for dosing pump to dose either oxidant or reductant products. These contacts act only as a switch for the power to the drive;

4. Recorder output (**M1** ⇒ + mA output, **M2** ⇒ - mA output);

5. BNC for ORP electrode;

6. Connection for Potential Matching Pin;

7. Connection for Electrode Reference.

Note: Be sure your main line is protected by a fuse.

MECHANICAL DIMENSIONS

Front view of the panel-mounted unit.

Dimensions show the cutout size for the installation and also the outside dimensions of the panel.

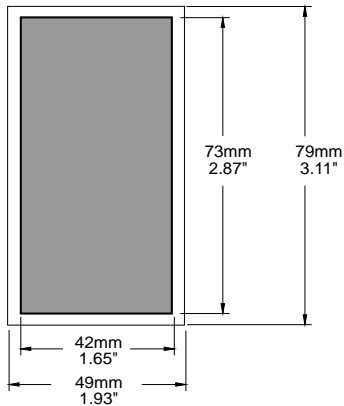

Side view of the panel-mounted unit.

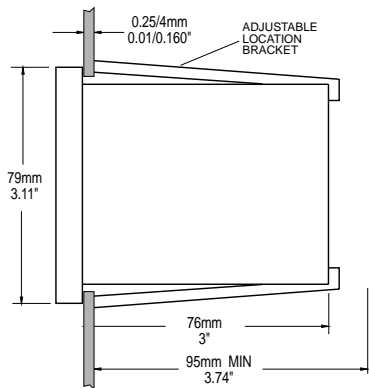

Adjustable location brackets (supplied with the meter) allow the controller to slide into the cutout and will hold the unit securely in place. 95 mm (3.74") is the minimum amount of space required to install the controller with the cables connected.

SPECIFICATIONS HI 931700

HI 931700	
Range	0.00 to 14.00 pH
Resolution	0.01 pH
Accuracy	±0.02 pH
Typical EMC Deviation	±0.02 pH
Installation Cat.	II
Input	10 ¹² Ohm
Calibration	Offset: ±2 pH through Offset trimmer Slope: 80 to 110% through slope trimmer
Readout	4-digit LCD plus graphic symbols
Recorder Output	0 to 20mA or 4 to 20mA (not isolated)
Set Point Relay	Isolated, 2A, max 240 V, resistive load, 1.000.000 strokes
Power Supply	115±10% or 230±10% VAC, 50/60 Hz or 15-24VDC (according to the model)
Environment	-10 to 50°C (14 to 122°F)
Weight	130 g (4.58 oz)

SPECIFICATIONS HI 932700

HI 932700	
Range	-1000 to +1000 mV
Resolution	1 mV
Accuracy	±5 mV
Typical EMC Deviation	±2 mV
Installation Cat.	II
Input	10 ¹² Ohm
Calibration	Slope: 90 to 110% through slope trimmer
Readout	4-digit LCD plus graphic symbols
Recorder Output	0 to 20 mA or 4 to 20 mA (not isolated)
Set Point Relay	Isolated, 2 A, max 240 V, resistive load, 1.000.000 strokes
Power Supply	115±10% or 230±10% VAC, 50/60 Hz or 15-24VDC (according to the model)
Environment	-10 to 50°C (14 to 122°F)
Weight	130 g (4.58 oz)

INITIAL PREPARATION

- Connect a 3-wire (115 or 230VAC versions) or 2-wire (15-24VDC version) power cable to the terminal strip paying attention to the correct live, earth and neutral (115 or 230VAC version) or positive and negative (15-24VDC version) terminal connections.

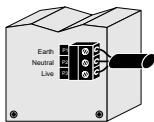

- Connect the pH or ORP electrode to the BNC connector marked "INPUT ELECTRODE".

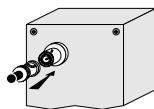

- To benefit from the differential input, connect the proper electrode wire (if available) or a cable with a potential matching pin (grounding bar) to the relevant terminal (# 6 at pages 5 and 7).

Note: When it is not possible to immerse the Potential Matching Pin together with the electrode in the solution, disable the differential input by connecting the connection for Potential Matching Pin with the connection for Electrode Reference with a jumper wire.

- Recorder Terminals: these contacts are the output terminals for connection to a recorder. The output is from 0 to 20 mA or 4 to 20 mA as indicated and is proportional to the measured pH or ORP value.

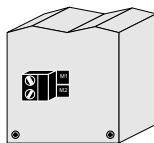

Note: Calibrate the external recorder to be in accordance with the display reading (consult recorder manufacturer instruction manual).

- HI 931700 and HI 932700 are single set point dosing controllers for dosing respectively acid or alkaline / reducing or oxidizing products.

HI 931700: If you plan to dose acid (e.g. in hexavalent chromium reduction), make an open circuit between terminals marked "S1" and "S2" on the rear panel (description on page 3).

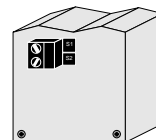

If you plan to dose base (e.g. in cyanide oxidation), short terminals "S1" and "S2".

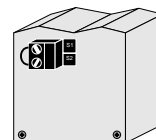

HI 932700: If you plan to dose oxidants (e.g. in cyanide oxidation), make a short circuit between terminals marked "S1" and "S2" on the rear panel (description at page 5).

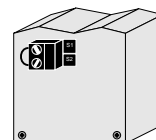

If you plan to dose reductants (e.g. in hexavalent chromium reduction), make an open circuit across terminals "S1" and "S2".

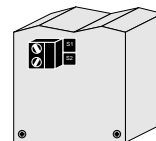

- Set Contacts: these contacts (maximum 2A, 220 V) are used for connection to dosing pumps. Use HI 931700 for dosage of acidic or alkaline reagents, and HI 932700 for dosage of oxidizing or reducing reagents. Both units act as a switch for power to the control element (e.g. pump).



Note: all external cables connected to the rear panel should end with cable lugs.

OPERATIONAL GUIDE

The setting of the various parameters are made via the front panel keys and trimmers. When each key is pressed the LED is lighted indicating to the user that the function is in operation.

Make sure that the meters and electrodes are calibrated before operating the instruments (see page 13).

To set the working point of pH or ORP dosage, press the "SET" key. The display will show the set value for the dosage.

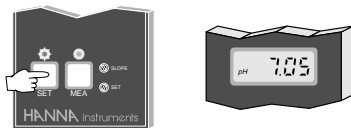

Use a small screwdriver to adjust the "SET" trimmer until the desired set value is displayed.

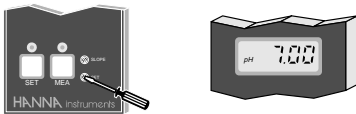

After setting the pH or ORP value immerse the electrode in the test solution and press the "MEASURE" key. The actual pH or ORP value of the test solution is displayed.



When the chemicals are dosed, the "SET ON" LED will be lit.



CALIBRATION

Make sure the meter is in the measurement mode (MEASURE LED light is on) before starting the calibration procedure.

HI 931700:

Note the temperature of the buffer solution using a thermometer.

Immerse the electrode and the Potential Matching Pin in pH 7.01 buffer solution (HI 7007).



Note: When it is not possible to immerse the Potential Matching Pin together with the electrode in the solution, disable the differential input by connecting the connection for Potential Matching Pin with the connection for Electrode Reference with a jumper wire.

Shake briefly and wait one minute before adjusting the Offset trimmer to

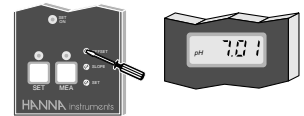

display pH 7.01 on the LCD if the temperature of the buffer solution is at 25°C.

If the buffer solution temperature is not 25°C, refer to Table 1 for the appropriate buffer value to adjust at the noted temperature.

Rinse the electrode and the Potential Matching Pin thoroughly in water and immerse them in 4.01pH (HI7004) or 10.01pH (HI7010) buffer solution.

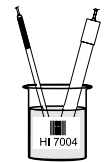

Shake briefly and wait one minute before adjusting the slope trimmer to display pH 4.01 (or 10.01) on the LCD if the temperature of the

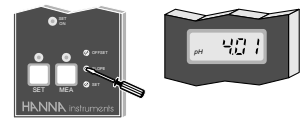

buffer solution is at 25°C, if not refer to Table 1 for appropriate buffer value at the corresponding temperature.

Temperature		Buffer	Buffer	Buffer	Buffer	Buffer
°C	°F	pH4.01	pH6.86	pH7.01	pH9.18	pH10.01
0	32	4.01	6.98	7.13	9.46	10.32
5	41	4.00	6.95	7.10	9.39	10.24
10	50	4.00	6.92	7.07	9.33	10.18
15	59	4.00	6.90	7.04	9.27	10.12
20	68	4.00	6.88	7.03	9.22	10.06
25	77	4.01	6.86	7.01	9.18	10.01
30	86	4.02	6.85	7.00	9.14	9.96
35	95	4.03	6.84	6.99	9.10	9.92
40	104	4.04	6.84	6.98	9.07	9.88
45	113	4.05	6.83	6.98	9.04	9.85
50	122	4.06	6.83	6.98	9.01	9.82
55	131	4.07	6.84	6.98	8.99	9.79
60	140	4.09	6.84	6.98	8.97	9.77
65	149	4.11	6.85	6.99	8.95	9.76
70	158	4.12	6.85	6.99	8.93	9.75
75	167	4.14	6.86	7.00	8.91	9.74
80	176	4.16	6.86	7.01	8.89	9.73
85	185	4.17	6.87	7.02	8.87	9.74
90	194	4.19	6.88	7.03	8.85	9.75
95	203	4.20	6.89	7.04	8.83	9.76

Table 1

Note: For better accuracy, calibrate the meter using a calibration solution at the same temperature of the liquid to be measured.

If calibration is performed at a different temperature, the error is approx. 0.0035pH for each 1°C difference multiplied by the difference between the pH of the measured liquid and pH7; e.g. meter calibrated at 25°C/measured liquid: pH 4 / liquid temperature: 35°C; the error is approx.:

$$0.0035 \times (35 - 25) \times (7 - 4) = 0.10 \text{ pH.}$$

The error is added or subtracted to the reading according to table 2.

	Temp. above 25°C	Temp. below 25°C
pH above 7	Subtract	Add
pH below 7	Add	Subtract

Table 2

HI 932700:

Immerse the electrode and the Potential Matching Pin in HI 7020 ORP solution.

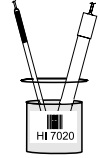

Note: When it is not possible to immerse the Potential Matching Pin together with the electrode in the solution, disable the differential input by connecting the connection for Potential Matching Pin with the connection for Electrode Reference with a jumper wire.

Adjust the slope trimmer until an ORP value from 200 mV and 275 mV is displayed.



The calibration is now complete and the instrument is ready for use.

TAKING REDOX MEASUREMENTS

Redox measurements allow the quantification of the oxidizing or reducing power of a solution, and are commonly expressed in mV.

Oxidation may be defined as the process during which a molecule (or an ion) loses electrons and reduction as the process by which electrons are gained.

Oxidation is always coupled together with reduction so that as one element gets oxidized, the other automatically is reduced, therefore the term oxidation-reduction is frequently used.

Redox potentials are measured by an electrode capable of absorbing or releasing electrons without causing a chemical reaction with the elements with which it comes into contact.

The electrodes most usually available for this purpose have gold or platinum surfaces; gold possesses a higher resistance than platinum in conditions of strong oxidation, while platinum is preferred for the measurements of oxidizing solutions containing halides and for more general uses.

When a platinum electrode is immersed in an oxidizing solution a monomolecular layer of oxygen is developed on its surface. This layer does not prevent the electrode from functioning, but it increases the response time. The opposite effect is obtained when the platinum surface absorbs hydrogen in the presence of reducing mediums. This phenomenon is rough on the electrode.

To make correct redox measurements the following conditions must prevail:

- The surface of the electrode must be cleaned and smooth.
- The surface of the electrode must undergo a preventive treatment depending whether the solution to be measured has oxidizing or reductive characteristics.

Because the Pt/PtO system depends on the pH, the pretreatment of the electrode may be determined by the pH and the redox potential of the solution to be measured.

As a general rule, if the ORP mV reading corresponding to the pH solution value is higher than the value in the Table below, an oxidizing pre-treatment is necessary; otherwise a reducing pre-treatment is necessary:

pH	mV	pH	mV	pH	mV	pH	mV	pH	mV
0	990	1	920	2	860	3	800	4	740
5	680	6	640	7	580	8	520	9	460
10	400	11	340	12	280	13	220	14	160

Reducing pre-treatment: immerse the electrode for a few minutes in **HI 7091**.

Oxidizing pre-treatment: immerse the electrode for a few minutes in **HI 7092**.

If pre-treatment is not performed, the electrode will take a significantly longer time to respond.

When working with electrodes of the refilling type, the electrolyte used for filling must be constantly kept at an adequate level (no less than 2½ centimeters from the filling hole) and topped up if necessary with **HI 7071** refilling solution.

In the event that measurements are performed with solutions containing sulfides or proteins, the cleaning of the diaphragm of the reference electrode must be performed (see page 21, "Cleaning Procedure").

In order to have a correct functioning of the ORP electrode, immerse it into **HI 7020** and measure the response; the obtained value should be within 200 and 275 mV.

After this functional test, it is suggested to wash the electrode thoroughly with water and proceed to the oxidizing or reducing pre-treatment before taking measurements.

When not in use, the electrode tip should be kept moist and far from any type of mechanical stress which might cause damage. For this reason, the use of the protective cap supplied with the electrode is advised.

ELECTRODE CONDITIONING AND MAINTENANCE

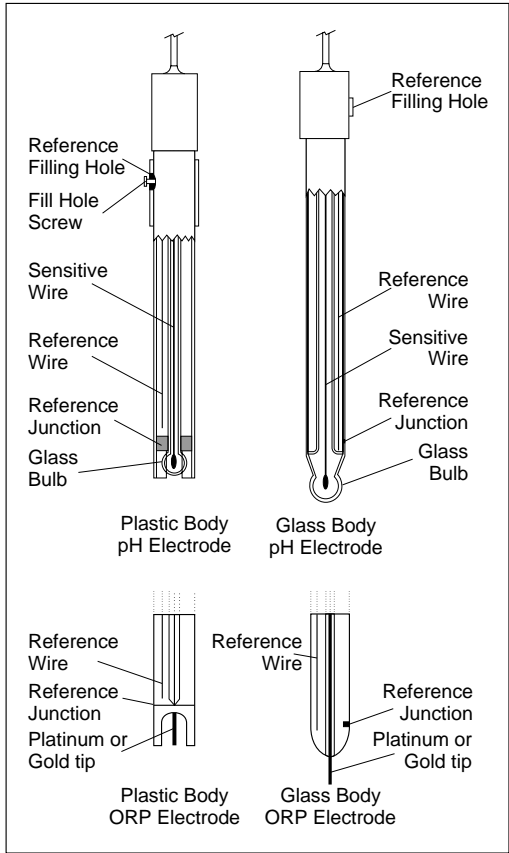

PREPARATION

Remove the protective cap.

DO NOT BE ALARMED IF ANY SALT DEPOSITS ARE PRESENT.

This is normal with electrodes and they will disappear when rinsed with water.

During transport tiny bubbles of air may have formed inside the glass bulb. The electrode

cannot function properly under these conditions. These bubbles can be removed by "shaking down" the electrode as you would do with a glass thermometer.

If the bulb and/or junction are dry, soak the electrode in **HI70300** Storage Solution for at least one hour.

For refillable electrodes:

If the fill solution (electrolyte) is more than 1 cm (½") below the fill hole, add **HI7082 3,5M KCl Electrolyte Solution** for double junction or **HI7071 3,5M KCl+AgCl Electrolyte Solution** for single junction electrodes. For a faster response unscrew the fill hole screw during measurements.

For AmpHel® electrodes:

If the electrode does not respond to pH changes, the battery is run down and the electrode should be replaced.

MEASUREMENT

Rinse the electrode tip with distilled water.

Immerse the tip (4 cm / 1½") in the sample and stir gently for approx. 30 seconds.

For a faster response and to avoid cross contamination of the samples, rinse the electrode tip with a few drops of the solution to be tested, before taking measurements.

STORAGE

To minimize clogging and assure a quick response time, the glass bulb and the junction should be kept moist and not allowed to dry out.

Replace the solution in the protective cap with a few drops of **HI70300 Storage Solution** or, in its absence, **Filling Solution (HI7071 for single junction or HI7082 for double junction electrodes)**.

AmpHel® is a registered Trademark of "Hanna Instruments"

Follow the Preparation Procedure above before taking measurements.

Note: NEVER STORE THE ELECTRODE IN DISTILLED WATER OR DRY.

PERIODIC MAINTENANCE

Inspect the electrode and the cable. The cable used for the connection to the meter must be intact and there must be no points of broken insulation on the cable or cracks on the electrode stem or bulb.

Connectors must be perfectly clean and dry. If any scratches or cracks are present, replace the electrode. Rinse off any salt deposits with water.

For refillable electrodes:

Refill the electrode with fresh electrolyte (**HI7071** for single junction or **HI7082** for double junction electrodes). Allow the electrode to stand upright for 1 hour.

Follow the Storage Procedure above.

CLEANING PROCEDURE

General Soak in Hanna **HI7061 General Cleaning Solution** for approximately 1 hour.

Removal of films, dirt or deposits on the membrane/junction:

Protein Soak in Hanna **HI7073 Protein Cleaning Solution** for 15 minutes.

Inorganic Soak in Hanna **HI7074 Inorganic Cleaning Solution** for 15 minutes.

Oil/grease Rinse with Hanna **HI7077 Oil and Fat Cleaning Solution**.

IMPORTANT: After performing any of the cleaning procedures rinse the electrode thoroughly with distilled water, drain and refill the reference chamber with fresh electrolyte, (not necessary for GEL filled electrodes) and soak the electrode in **HI70300 Storage Solution** for at least 1 hour before taking measurements.

TROUBLESHOOTING

Evaluate your electrode performance based on the following.

- **Noise** (Readings fluctuate up and down) could be due to:
 - **Clogged/Dirty Junction:** Refer to the Cleaning Procedure above.
 - **Loss of shielding** due to low electrolyte level (in refillable electrodes only): refill with **HI7071** for single junction or **HI7082** for double junction electrodes.
- **Dry Membrane/Junction:** Soak in **Storage Solution HI70300** for at least 1 hour.
- **Drifting:** Soak the electrode tip in warm Hanna Solution **HI7082** for one hour and rinse tip with distilled water. Refill with fresh **HI7071** for single junction electrodes and **HI7082** for double junction electrodes.
- **Low Slope:** Refer to the cleaning procedure above.
- **No Slope:** Check the electrode for cracks in glass stem or bulb (replace the electrode if cracks are found).
- **Slow Response/Excessive Drift:** Soak the tip in Hanna Solution **HI7061** for 30 minutes, rinse thoroughly in distilled wa-

ter and then follow the Cleaning Procedure above.

- **For ORP Electrodes:** polish the metal tip with a light abrasive paper (paying attention not to scratch the surface) and wash thoroughly with water.

TEMPERATURE-RESISTANCE CORRELATION FOR HANNA pH SENSITIVE GLASS

The resistance of glass electrodes partially depends on the temperature. The lower the temperature, the higher the resistance. It takes longer time for the reading to stabilize if the resistance is higher. In addition, the response time will suffer to a greater degree at temperatures below 10°C.

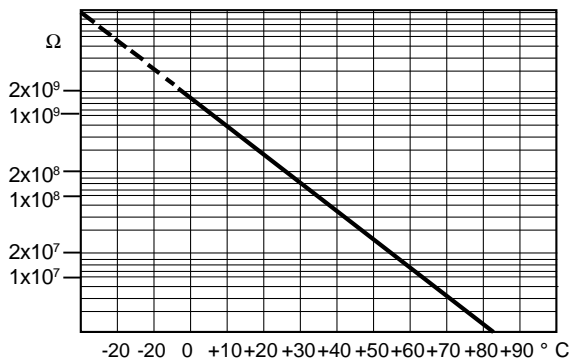

Since the resistance of the pH electrode is in the range of 200 Mohm, the current across the membrane is in the pico Ampere range. Large currents can disturb the calibration of the electrode for many hours.

For these reasons **high humidity environments, short circuits and static discharges** are detrimental for a stable pH reading.

The pH electrode's life also depends on the temperature. If constantly used at high temperatures, the electrode life is drastically reduced.

Typical Electrode Life

Ambient Temperature	1- 3 years
90 °C	Less than 4 months
120°C	Less than 1 month

High concentrations of sodium ions interfere with readings in alkaline solutions; the pH at which the interference starts to be significant depends upon the composition of the glass. This interference is the alkaline error and causes the pH readings to be underestimated. Hanna's glass formulations have the indicated characteristics.

Alkaline Error

Sodium Ion Correction for the Glass at 20-25°C		
Concentration	pH	Error
0.1 Mol L ⁻¹ Na ⁺	13.00	0.10
	13.50	0.14
	14.00	0.20
1.0 Mol L ⁻¹ Na ⁺	12.50	0.10
	13.00	0.18
	13.50	0.29
	14.00	0.40

SUGGESTED INSTALLATIONS

SHORT DISTANCE, INDOOR INSTALLATION

Due to the high impedance of the pH and ORP electrode's glass membrane (usually more than 100 M Ω), a very high grade of insulation is required.

A dry environment is needed in order to obtain a level of insulation not lower than 10¹² Ω .

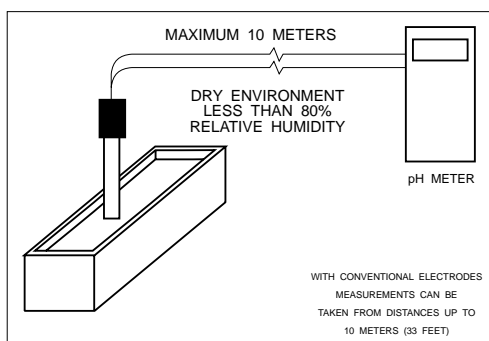

This type of connection is very delicate and requires constant attention to maintain proper operating conditions.

The conventional electrodes should be used in indoor applications only, and should not use a cable longer than 10 m (33').

MEDIUM DISTANCE, INDOOR/OUTDOOR INSTALLATION

Since the introduction of AmpHel[®] these distances are no longer a problem. You are now able to connect your meter directly to an AmpHel[®] electrode, saving the cost of a transmitter or costly coaxial cable.

The standard cable length of the AmpHel[®] electrode is 5 m (16.5'). Additional lengths of regular cable up to 50 m (165'), can be installed without special connectors.

AmpHel[®] is a registered Trademark of "Hanna Instruments"

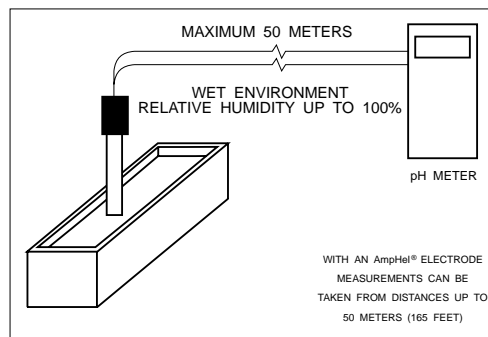

AmpHel[®] electrodes have a micro-amplifier in the electrode cap to boost the signal, drastically reducing susceptibility to noise and drift.

With all of the components sealed in the electrode body, moisture up to 100% RH will not effect the signal.

AmpHel[®] is a registered Trademark of "Hanna Instruments"

ACCESSORIES

pH CALIBRATION SOLUTIONS

- HI7004M** pH 4.01 Buffer Solution, 230 mL
HI7004L pH 4.01 Buffer Solution, 460 mL
HI7006M pH 6.86 Buffer Solution, 230 mL
HI7006L pH 6.86 Buffer Solution, 460 mL
HI7007M pH 7.01 Buffer Solution, 230 mL
HI7007L pH 7.01 Buffer Solution, 460 mL
HI7009M pH 9.18 Buffer Solution, 230 mL
HI7009L pH 9.18 Buffer Solution, 460 mL
HI7010M pH 10.01 Buffer Solution, 230 mL
HI7010L pH 10.01 Buffer Solution, 460 mL

ORP SOLUTIONS

- HI 7020M** 200-275mV Buffer Solution, 230 mL
HI 7020L 200-275mV Buffer Solution, 460 mL
HI 7091M Pre-Treatment Reducing Solution, 230 mL
HI 7091L Pre-Treatment Reducing Solution, 460 mL
HI 7092M Pre-treatment Oxidizing Solution, 230 mL
HI 7092L Pre-Treatment Oxidizing Solution, 460 mL

ELECTRODE STORAGE SOLUTIONS

- HI70300M** Storage Solution, 230 mL
HI70300L Storage Solution, 460 mL

ELECTRODE CLEANING SOLUTIONS

- HI7061M** General Cleaning Sol., 230 mL
HI7061L General Cleaning Sol., 460 mL
HI7073M Protein Cleaning Sol., 230 mL
HI7073L Protein Cleaning Sol., 460 mL
HI7074M Inorganic Cleaning Sol., 230 mL
HI7074L Inorganic Cleaning Sol., 460 mL
HI7077M Oil & Fat Cleaning Sol., 230 mL
HI7077L Oil & Fat Cleaning Sol., 460 mL

REFILLING ELECTROLYTE SOLUTIONS

- HI7071** 3.5M KCl + AgCl Electrolyte, 4x50 mL, for single junction electrodes
HI7072 1M KNO₃ Electrolyte, 4x50 mL
HI7082 3.5M KCl Electrolyte, 4x50 mL, for double junction electrodes

pH ELECTRODES

- HI 1090T** Screw cap PG13.5 connector, double junction, glass-body

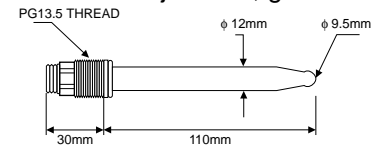

- HI 1110S** Screw connector, single junction, glass-body

- HI 1130B/3** BNC connector, 3 m (9.9') cable, single junction, glass-body

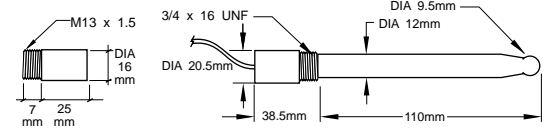

HI 1110S

HI 1130B/3

- HI 1110T** Screw cap PG13.5 connector, double junction, glass-body

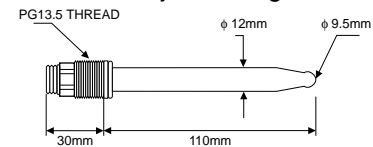

- HI 1114S** Screw connector, double junction plastic-body

- HI 1134B/3** BNC connector, 3 m (9.9') cable, double junction plastic-body

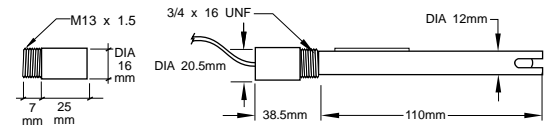

HI 1114S

HI 1134B/3

- HI 1115S** Screw connector, single junction, glass-body

- HI 1135B/3** BNC connector, 3 m (9.9') cable, single junction, glass-body

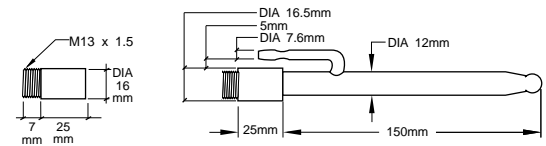

HI 1115S

HI 1135B/3

HI 1210T Screw cap PG13.5 connector, double junction, plastic-body

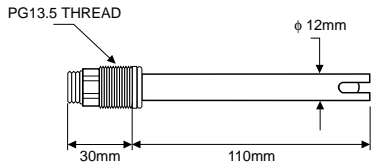

HI 1910B BNC connector, 1 m (3.3') cable, double junction, plastic-body, built-in amplifier

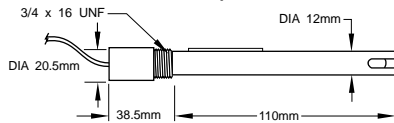

HI 1911B BNC connector, 1 m (3.3') cable, double junction, plastic-body, built-in amplifier

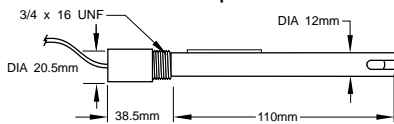

HI 1912B BNC connector, 1 m (3.3') cable, double junction, plastic-body, built-in amplifier

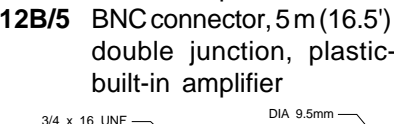

HI 1912B/5 BNC connector, 5 m (16.5') cable, double junction, plastic-body, built-in amplifier

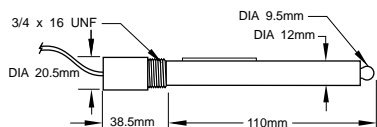

HI 2114B/5 BNC connector, 5 m (16.5') cable, double junction, plastic-body

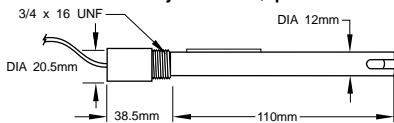

HI 2910B/5 BNC connector, 5 m (16.5') cable, double junction, plastic-body, built-in amplifier

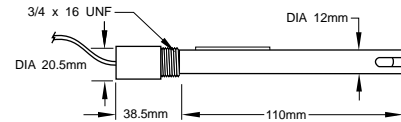

ORP ELECTRODES

HI 2930B/5 BNC connector, 5 m (16.5') cable, Pt, Ultem®-body, built-in amplifier

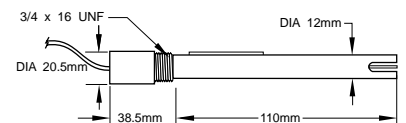

HI 3110S Screw-type connector, Pt, glass-body

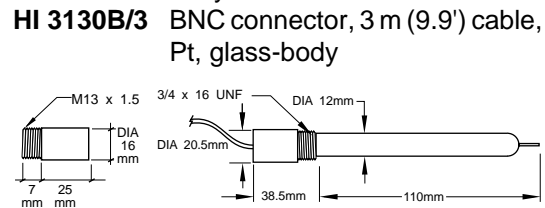

HI 3110S **HI 3130B/3**

HI 3110T Screw cap PG13.5 connector, Pt, glass-body

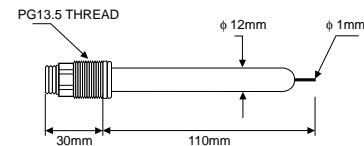

HI 3115S Screw-type connector, side-arm, Pt, glass-body

HI 3135B/3 BNC connector, 3 m (9.9') cable, side-arm, Pt, glass-body

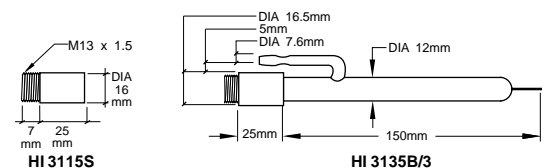

HI 3115S **HI 3135B/3**

Ultem® is a registered Trademark of "General Electric Company"

HI 3210T Screw cap PG13.5 connector, Pt, plastic-body

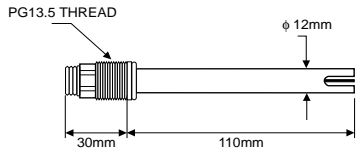

HI 3410S Screw connector, Pt, plastic-body
HI 3430B/3 BNC connector, 3 m (9.9') cable, Pt, plastic-body

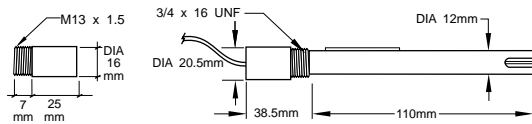

HI 3932B/5 BNC connector, 5 m (16.5') cable, Pt, Ultem®-body, built-in amplifier

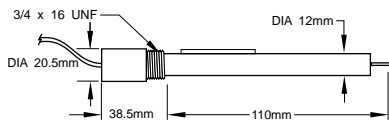

HI 4110S Screw-type connector, Au, glass-body

HI 4130B/3 BNC connector, 3 m (9.9') cable, Au, glass-body

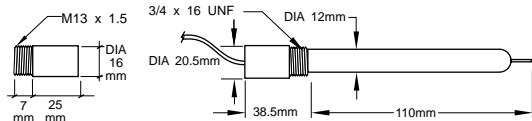

HI 4932B/5 BNC connector, 5 m (16.5') cable, Au, Ultem®-body, built-in amplifier

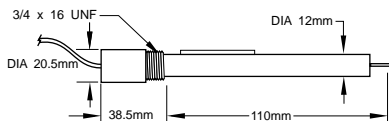

EXTENSION CABLES FOR SCREW-TYPE ELECTRODES ONLY (SCREW TO BNC CONNECTOR)

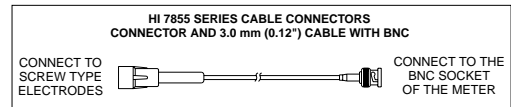

- HI7855/1** Extension cable 1m (3.3') long
- HI7855/3** Extension cable 3m (9.9') long
- HI7855/5** Extension cable 5m (16.5') long
- HI7855/10** Extension cable 10m (33') long
- HI7855/15** Extension cable 15m (49.5') long

OTHER ACCESSORIES

BL PUMPS Dosing Pumps with Flow Rate from 1.5 to 20 LPH

ChecktempC Pocket-size thermometer with penetration probe and 0.1°C resolution (range -50.0 to 150.0°C)

HI 6050 & HI 6051 Submersible Electrode Holders

HI 6054 & HI 6057 Electrode Holders for In-Line Applications

HI731326 Calibration Screwdriver (20 pcs)

HI 7871 & HI 7873 Level Controllers

HI8427 pH and ORP Electrode Simulator with 1 m (3.3') Coaxial Cable ending in Female BNC Connectors (HI 7858/1)

HI931001 pH and ORP Electrode Simulator with LCD Display and 1 m (3.3') Coaxial Cable ending in Female BNC Connectors (HI 7858/1)

MANMINPRR2 Instruction Manual

Ultem® is a registered Trademark of "General Electric Company"

WARRANTY

All Hanna Instruments **meters are warranted for two years** against defects in workmanship and materials when used for their intended purpose and maintained according to instructions.

The probes and the electrodes are warranted for a period of six months.

Damages due to accident, misuse, tampering or lack of prescribed maintenance are not covered. This warranty is limited to repair or replacement free of charge.

If service is required, contact the dealer from whom you purchased the instrument. If under warranty, report the model number, date of purchase, serial number and the nature of the failure. If the repair is not covered by the warranty, you will be notified of the charge for repair or replacement. When shipping any instrument, make sure it is properly packaged for complete protection.

To validate your warranty, fill out and return the enclosed warranty card within 14 days from the date of purchase.

All rights are reserved. Reproduction in whole or in part is prohibited without the written consent of the copyright owner.

Hanna Instruments reserves the right to modify the design, construction and appearance of its products without advance notice.

CE DECLARATION OF CONFORMITY



DECLARATION OF CONFORMITY

We

Hanna Instruments Srl
V.le delle industrie 12
35010 Ronchi di Villafranca (PD)
ITALY

herewith certify that the panel mounted pH / ORP controllers

HI 931700 HI 932700

have been tested and found to be in compliance with the following regulations:

IEC 801-2	Electrostatic Discharge
IEC 801-3	RF Radiated
IEC 801-4	Fast Transient
EN 55022	Radiated, Class B

Date of Issue: 16-04-1996

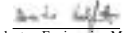
D. Volpato - Engineering Manager
On behalf of
Hanna Instruments S.r.l.

Recommendations for Users

Before using these products, make sure that they are entirely suitable for the environment in which they are used.

Operation of these instruments in residential area could cause unacceptable interferences to radio and TV equipments, requiring the operator to take all necessary steps to correct interferences.

The trimmers are sensitive to electrostatic discharges. It is recommended to use anti-static screwdriver.

Any variation introduced by the user to the supplied equipment may degrade the instruments' EMC performance.

To avoid electrical shock, do not use these instruments when voltages at the measurement surface exceed 24VAC or 60VDC.

To avoid damages or burns, do not perform any measurement in microwave ovens.



PRINTED IN
PORTUGAL

MANMINPRR2
02/99



<http://www.hannainst.com>