

SALES & TECHNICAL SERVICE CONTACTS

Australia:

Tel. (03) 9769.0666 • Fax (03) 9769.0699

China:

Tel. (10) 88570068 • Fax (10) 88570060

Egypt:

Tel. & Fax (02) 2758.683

Germany:

Tel. (07851) 9129-0 • Fax (07851) 9129-99

Greece:

Tel. (210) 823.5192 • Fax (210) 884.0210

Indonesia:

Tel. (21) 4584.2941 • Fax (21) 4584.2942

Japan:

Tel. (03) 3258.9565 • Fax (03) 3258.9567

Korea:

Tel. (02) 2278.5147 • Fax (02) 2264.1729

Malaysia:

Tel. (603) 5638.9940 • Fax (603) 5638.9829

Singapore:

Tel. 6296.7118 • Fax 6291.6906

South Africa:

Tel. (011) 615.6076 • Fax (011) 615.8582

Taiwan:

Tel. 886.2.2739.3014 • Fax 886.2.2739.2983

Thailand:

Tel. (662) 619.0708.11 • Fax (662) 619.0061

United Kingdom:

Tel. (01525) 850.855 • Fax (01525) 853.668

USA:

Tel. (401) 765.7500 • Fax (401) 765.7575

For e-mail contacts and a complete list of Sales and Technical offices, please see www.hannainst.com.

Instruction Manual

HI 8424NEW

**Portable pH/mV/°C Meter
with Automatic Calibration and
Battery Recharging System**

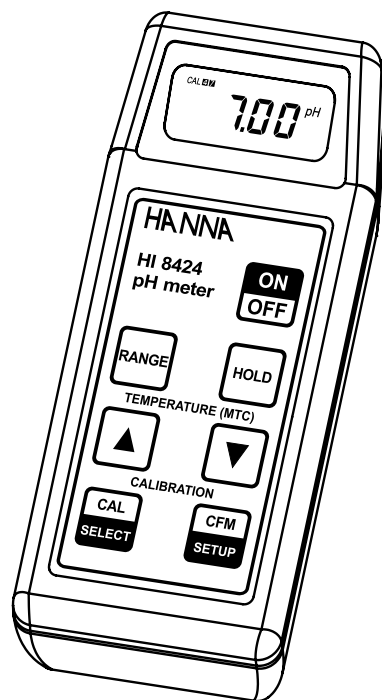

MAN8424W R1 10/05

HANNA
instruments
www.hannainst.com

Dear Customer,

Thank you for choosing a HANNA instruments® product.

Please read this instruction manual carefully before using the instrument.

This manual will provide you with the necessary information for correct use of the instrument, as well as a precise idea of its versatility.

If you need additional technical information, do not hesitate to e-mail us at tech@hannainst.com or see the back cover for our worldwide contact list.

This instrument is in compliance with the **CE** directives.

WARRANTY

HI 8424NEW is guaranteed for two years against defects in workmanship and materials when used for its intended purpose and maintained according to instructions. **Electrodes and probes are guaranteed for six months.** This warranty is limited to repair or replacement free of charge. Damage due to accidents, misuse, tampering or lack of prescribed maintenance is not covered. If service is required, contact the dealer from whom you purchased the instrument. If under warranty, report the model number, date of purchase, serial number and the nature of the problem. If the repair is not covered by the warranty, you will be notified of the charges incurred. If the instruments are to be returned to Hanna Instruments, first obtain a Returned Goods Authorization number from the Technical Service department and then send it with shipping costs prepaid. When shipping any instrument, make sure it is properly packed for complete protection.

TABLE OF CONTENTS

PRELIMINARY EXAMINATION	3
GENERAL DESCRIPTION	3
FUNCTIONAL DESCRIPTION	4
SPECIFICATIONS	5
OPERATIONAL GUIDE	6
pH CALIBRATION	9
pH BUFFER TEMPERATURE DEPENDENCE	11
MENU SELECTION	12
mV CALIBRATION	13
TEMPERATURE CALIBRATION	13
BATTERY RECHARGE AND REPLACEMENT	14
LCD MESSAGES AND TROUBLESHOOTING	15
ELECTRODE CONDITIONING & MAINTENANCE	16
ACCESSORIES	19
pH ELECTRODE APPLICATION REFERENCE GUIDE	25
CE DECLARATION OF CONFORMITY	19

All rights are reserved. Reproduction in whole or in part is prohibited without the written consent of the copyright owner.

Hanna Instruments reserves the right to modify the design, construction and appearance of its products without advance notice.

CE DECLARATION OF CONFORMITY



CE
DECLARATION OF CONFORMITY

We
Hanna Instruments Italia Srl
viale delle Industrie, 12/A
35010 Ronchi di Villafranca - PD
ITALY

herewith certify that the instrument:

HI 8424NEW

has been tested and found to be in compliance with EMC Directive 89/336/EEC and Low Voltage Directive 73/23/EEC according to the following applicable normatives:

- EN 50082-1: Electromagnetic Compatibility - Generic Immunity Standard
- IEC 61000-4-2 Electrostatic Discharge
- IEC 61000-4-3 RF Radiated
- EN 50081-1: Electromagnetic Compatibility - Generic Emission Standard
- EN 55022 Radiated, Class B
- EN61010-1: Safety requirements for electrical equipment for measurement, control and laboratory use

Date of Issue: 22.1.2004

A. Marsilio - Technical Director
On behalf of
Hanna Instruments S.r.l.

RECOMMENDATIONS FOR USERS

Before using this product, make sure that it is entirely suitable for the environment in which it is used. Operation of this instrument in residential areas could cause unacceptable interferences to radio and TV equipment, requiring the operator to follow all necessary steps to correct interferences.

The glass bulb at the end of the pH electrode is sensitive to electrostatic discharges. Avoid touching this glass bulb at all times. During operation, ESD wrist straps should be worn to avoid possible damage to the electrode by electrostatic discharges.

Any variation introduced by the user to the supplied equipment may degrade the instrument's EMC performance.

To avoid electrical shock, do not use this instrument when voltages at the measurement surface exceed 24 Vac or 60 Vdc.

To avoid damage or burns, do not perform any measurement in microwave ovens.

PRELIMINARY EXAMINATION

Remove the instrument from the packing material and examine it carefully to make sure that no damage has occurred during shipment. If there is any damage, immediately notify your dealer.

The meter is supplied complete with:

- HI 1230B pH electrode
- HI 7662 temperature probe
- pH 4.01 & pH 7.01 buffer solutions, 20 mL each
- HI 700661 cleaning solution, 20 mL sachet (2 pcs)
- 9V Ni-MH rechargeable battery
- Instruction manual

Note: Save all packing material until you are sure that the instrument functions correctly. Any defective items must be returned in the original packing with the supplied accessories.

GENERAL DESCRIPTION

HI 8424NEW is a portable microprocessor-based pH/mV/temperature meter.

It features an enhanced user interface, rainproof casing, battery percentage indication, low battery detection, automatic shut-off, automatic calibration and error codes to guide the user in calibration and troubleshooting.

The instrument is also equipped with an inductive system for battery recharge, with no external contact, to ensure a watertight seal. Simply place the HI 8424NEW on the HI 710040 battery charger (optional), without needing to open the meter or remove the battery.

The pH calibration procedure automatically recognizes three memorized buffer values: pH 4.01, 7.01 and 10.01.

This instrument can also measure ORP. The resolution automatically switches from 0.1 mV to 1 mV when readings exceed ± 699.9 mV.

The user can set the following parameters by entering a setup mode through the keyboard:

- enabling or disabling the auto-off feature
- enabling or disabling the acoustic signal
- selecting the temperature unit, °C or °F

FUNCTIONAL DESCRIPTION

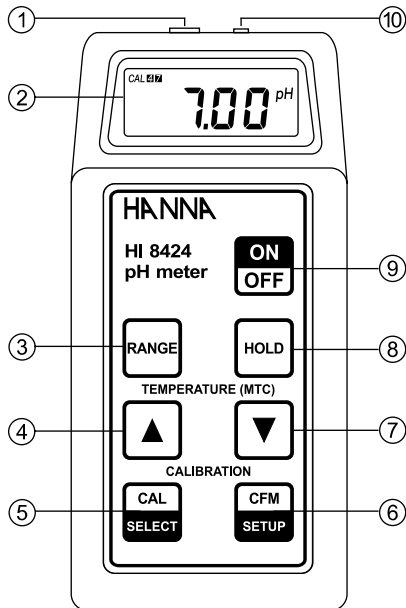

- 1) BNC connector for pH or ORP electrodes
- 2) Liquid Crystal Display (LCD)
- 3) **RANGE** key, to select pH, mV or temperature range
- 4) **Up Arrow** key, to manually set the temperature value when no temperature probe is connected
- 5) **CAL/SELECT** key, to enter calibration mode or select menu options
- 6) **CFM/SETUP** key, to confirm data or enter/exit setup menu
- 7) **Down Arrow** key, to manually set the temperature value when no temperature probe is connected
- 8) **HOLD** key, to freeze the reading on display
- 9) **ON/OFF** key, to switch the instrument ON or OFF
- 10) RCA socket for temperature probe

pH ELECTRODE APPLICATION REFERENCE GUIDE

Application	Electrodes *
1. Aquarium	HI 1332B, HI 1312S
2. Bath-water	HI 1130B, HI 1110S
3. Beer	HI 1131B, HI 1111S
4. Bread	HI 2031B, FC 200B, HI 2020S, FC 200S
5. Cheese	FC 200B, FC 200S
6. Dairy products	FC 911B, FC 100B
7. Dirty water	HI 1230B, HI 1210S
8. Emulsions	HI 1053B, HI 1050S
9. Environment	HI 1230B, HI 1210S
10. Flasks	HI 1331B, HI 1310S
11. Food industry general use	FC 911B, FC 100B
12. Fruit	FC 200B, FC 220B, FC 200S
13. Fruit juices, organic	FC 210B
14. Galvanizing waste solution	HI 1130B, HI 1110S
15. High purity water	HI 1053B, HI 1050S
16. Horticulture	HI 1053B, FC 200B, HI 1050S, FC 200S
17. Laboratory general use	HI 1131B, HI 1230B, HI 1332B, HI 1330B, HI 1111S, HI 1210S, HI 1312S, HI 1310S
18. Leather	HI 1413B, HI 1410S
19. Lemon juice	FC 100B
20. Meat	FC 200B, HI 2031B, FC 200S, HI 2020S
21. Micro plate sampling of less than 100mL	HI 1083B
22. Milk and Yogurt	FC 210B
23. Paints	HI 1053B, HI 1050S
24. Paper	HI 1413B, HI 1410S
25. Photographic chemicals	HI 1230B, HI 1210S
26. Quality control	HI 1332B, HI 1312S
27. Sausages	FC 200B, HI 2031B, FC 200S, HI 2020S
28. Semi-solid products	HI 2031B, HI 2020S
29. Skin	HI 1413B, HI 1410S
30. Soil samples	HI 1230B, HI 1210S
31. Solvents	HI 1043B, HI 1040S
32. Strong acid	HI 1043B, HI 1040S
33. Submersion application	HI 1130B, HI 1110S
34. Surface measurements	HI 1413B, HI 1410S
35. Swimming pool	HI 1130B, HI 2114P/2
36. Titrations with constant temperature range	HI 1131B, HI 1111S
37. Titrations with wide temperature range	HI 1131B, HI 1111S
38. Very high humidity	FC 911B
39. Vials and test tube	HI 1330B, HI 1310S
40. Wine processing	FC 220B

B = BNC-type connector

S = Screw-type connector

* All electrodes ending with "B" are supplied with 1 m (3.3') cable and BNC Connector

HI 4430B / HI 4410S

Plastic body, gel-filled, combination gold ORP electrode.

Use: general purpose.

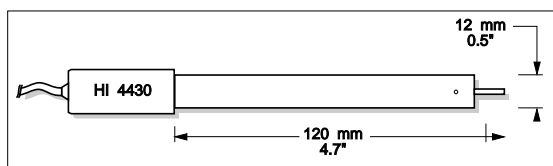

Consult the HANNA General Catalog for a complete and wide selection of electrodes.

EXTENSION CABLES FOR SCREW-TYPE ELECTRODES (SCREW TO BNC CONNECTOR)

HI 7855 SERIES CABLE CONNECTORS
CONNECTOR AND 3.0 mm (0.12") CABLE WITH BNC

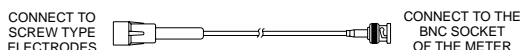

- HI 7855/1 Extension cable 1 m (3.3') long
- HI 7855/3 Extension cable 3 m (9.9') long
- HI 7855/5 Extension cable 5 m (16.5') long
- HI 7855/10 Extension cable 10 m (33') long
- HI 7855/15 Extension cable 15 m (49.5') long

OTHER ACCESSORIES

- HI 98501 *ChecktempC* pocket-size thermometer (-50.0 to 150.0°C)
- HI 98502 *ChecktempF* pocket-size thermometer (-58.0 to 302.0°F)
- HI 710015 Shockproof rubber boot, blue
- HI 710016 Shockproof rubber boot, orange
- HI 710022 Spare protective case
- HI 710040 No-contact, inductive battery charger
- HI 76405 Electrode holder
- HI 7662 Temperature probe with 1 m (3.3') screened cable
- HI 8427 pH/ORP electrode simulator with 1 m (3.3') coaxial cable and BNC connector
- HI 931001 pH/ORP electrode simulator with LCD, 1 m (3.3') coaxial cable and BNC connector

SPECIFICATIONS

Range	-2.00 to 16.00 pH ±699.9 mV / ±1999 mV -20.0 to 120.0°C / -4.0 to 248.0°F
Resolution	0.01 pH / 0.1 mV / 1 mV / 0.1°C / 0.1°F
Accuracy (@20°C/68°F)	±0.01 pH / ±0.2 mV / ±1 mV / ±0.4°C / ±0.8°F
Typical EMC Deviation	±0.02 pH / ±0.2 mV / ±1 mV / ±0.4°C / ±0.8°F
pH Calibration	Automatic, 1 or 2 point, with 3 memorized buffer values (pH 4.01, 7.01, 10.01) Offset: ±1 pH; Slope: from 75 to 110%
Temperature Compensation	Automatic, -20 to 120°C (-4 to 248°F) or manual without temperature probe
Probes (included)	HI 1230B double junction, gel-filled pH electrode HI 7662 temperature probe
Battery Type	1 x 9V, Ni-MH rechargeable
Battery Charge Life	Approx. 150 hours of continuous use
Battery Life	Approx. 5 years
Auto-off	After 20 minutes of non-use or disabled (user-selectable)
Environment	0 to 50°C (32 to 122°F); RH max 100%
Dimensions	164 x 76 x 45 mm (6.5 x 3.0 x 1.8")
Weight	180 g (6.3 oz.)

OPERATIONAL GUIDE

INITIAL PREPARATION

- Remove the electrode protective cap before taking any measurements. If the electrode has been left dry, soak the tip in HI 70300 storage solution for a few hours or overnight to reactivate it.
- Connect the pH electrode to the BNC connector on the top of the instrument.
- Connect the temperature probe to the RCA connector. The temperature probe can be used independently to take temperature measurements, or in conjunction with the pH electrode to utilize the ATC capability of the meter.
- Turn the meter ON by pressing the ON/OFF key. The display shows all the used segments for a few seconds (or as long as the button is held), followed by the percentage indication of the remaining battery life, and then enters normal measurement mode.



pH MEASUREMENTS

- To take a pH measurement simply submerge the electrode tip (at least 4 cm/1½") and the temperature probe into the sample to be tested.
- Select the pH mode by pressing the RANGE key until the display changes to pH.

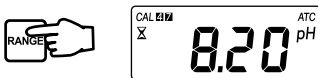
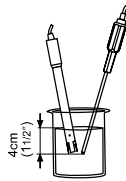

- Stir gently and wait for the stability symbol (hourglass) to turn off. The display will show the pH value automatically compensated for temperature.

Notes:

- In order to take accurate pH measurements, make sure that the instrument has been calibrated before use (see page 9).
- If measurements are taken in different samples successively, it is recommended to rinse the electrode thoroughly to avoid cross-contamination. After cleaning, it is recommended to rinse the electrode with some of the sample to be measured.

FC 220B

Glass body, triple ceramic, single junction, refillable, combination pH electrode. Use: food processing.

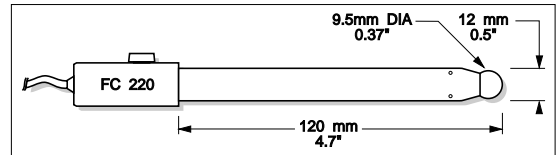

FC 911B

PVDF body, double junction, refillable with built-in amplifier, combination pH electrode. Use: very high humidity.

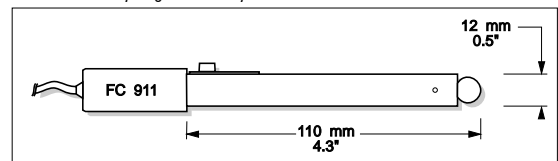

HI 1413B

Glass body, single junction, flat tip, Viscolene, non-refillable combination pH electrode. Use: surface measurement.

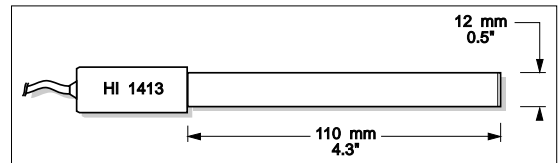

ORP ELECTRODES

HI 3131B / HI 3111S

Glass body, refillable, combination platinum ORP electrode. Use: titration.

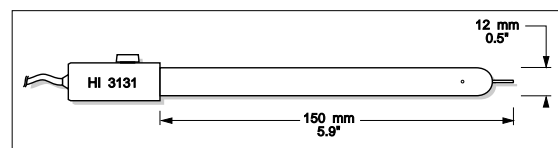

HI 3230B / HI 3210S

Plastic body, gel-filled, combination platinum ORP electrode. Use: general purpose.

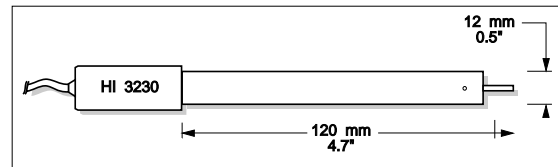

HI 1332B / HI 1312S

Plastic body, double junction, refillable, combination pH electrode.
Use: general purpose.

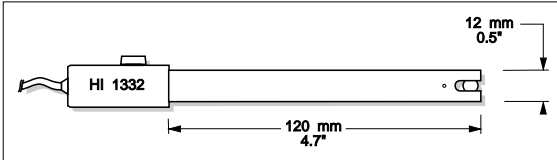

HI 2031B / HI 2020S

Glass body, semimicro, conic, refillable, combination pH electrode.
Use: semisolid products.

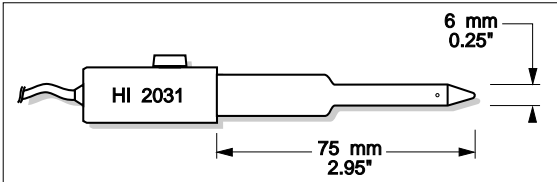

FC 100B

PVDF body, double junction, refillable, combination pH electrode.
Use: general purpose for food industry.

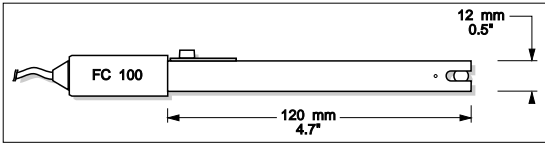

FC 200B / FC 200S

PVDF body, single junction, conic, Viscolene, non-refillable, combination pH electrode. Use: meat & cheese.

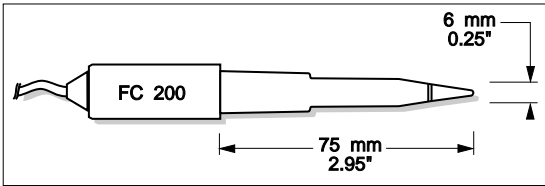

FC 210B

Glass body, double junction, conic, Viscolene, non-refillable combination pH electrode. Use: milk, yogurt.

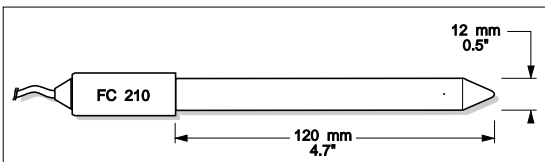

TEMPERATURE COMPENSATION

The meter is designed to compensate for temperature, as the response of the pH electrode is directly affected by temperature.

Automatic Temperature Compensation (ATC shown on LCD)

To use the ATC feature, submerge the temperature probe into the sample as close as possible to the electrode and wait for a few minutes. The displayed pH reading is compensated for the temperature of the sample.

Manual Temperature Compensation (MTC shown on LCD)

If the temperature probe is not connected, it is possible to enter the temperature value manually.

- Record the sample temperature by using a **ChecktempC** (if you are measuring temperature in °C, or **ChecktempF** for °F readings) or another accurate thermometer.
- Press **RANGE** to select the temperature mode. The "°C" (or "°F") symbol will blink to indicate that the temperature probe is not connected.



- Use the **UP** and **DOWN** keys to display and set the sample temperature (e.g. 25 °C).
- Press **RANGE** to select the pH measurement mode and immerse the electrode into the sample. The displayed pH reading will be temperature compensated at the set value (in this case at 25 °C).



ORP MEASUREMENTS

Oxidation Reduction Potential (ORP) measurements provide a quantification of the oxidizing or reducing power of the sample tested.

- Connect the ORP electrode (optional) to the BNC connector.
- To enter the "mV" mode turn the instrument ON and press the **RANGE** key until the display changes to mV.
- Submerge the ORP electrode tip (at least 4 cm / 1½") into the sample to be tested and allow time for the reading to stabilize (hourglass symbol turns off).
- Measurements within the ±699.9 mV range are displayed with 0.1 mV resolution, while outside this range the resolution is 1 mV.



Notes:

- To perform correct ORP measurements, the surface of the ORP electrode must be clean and smooth.
- When not in use, the tip of the electrode should be kept moist (use HI 70300 storage solution) and safe from any mechanical stress which might cause damage to the glass/platinum junction.

TEMPERATURE MEASUREMENTS

- Turn the instrument ON and press the RANGE key to select the temperature mode.
- Make sure the temperature probe is connected to the meter.
- Dip the temperature probe into the sample, allow the reading to stabilize (hourglass symbol turns off) and read the temperature value.
- Temperature measurements can be displayed in °C or °F units (see "Menu selection" for details).

Notes:

- A blinking full scale value means that the reading is out of range.
- To freeze a reading on display while in measurement mode, press the HOLD key. The "HOLD" tag will blink. The pH, mV and temperature values are held, and the RANGE key can be used to view the values. Press HOLD again to return to normal mode.
- If enabled, keypresses are followed with an acoustic signal. A lower note indicates that the key is not currently active.
- To save battery life, the meter is provided with an **auto-off feature**, which turns the instrument off after 20 minutes of non-use. This feature can be disabled by the user (see "Menu selection" for details).

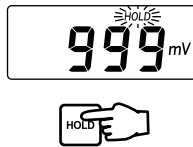

HI 1083B

Glass body, micro, Viscolene, non-refillable, combination pH electrode.
Use: biotechnology, micro titration.

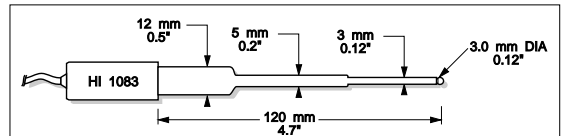

HI 1131B / HI 1111S

Glass body, single junction, refillable, combination pH electrode.
Use: general purpose.

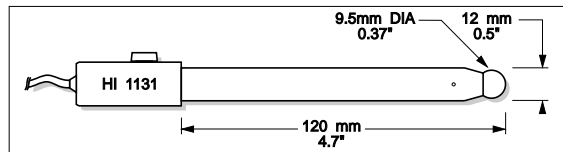

HI 1230B / HI 1210S

Plastic body, double junction, gel-filled, combination pH electrode.
Use: general purpose.

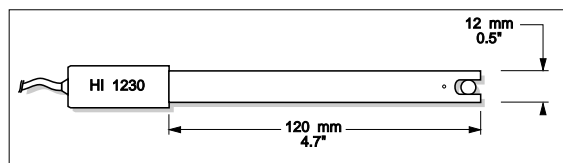

HI 1330B / HI 1310S

Glass body, semimicro, single junction, refillable, combination pH electrode.
Use: laboratory.

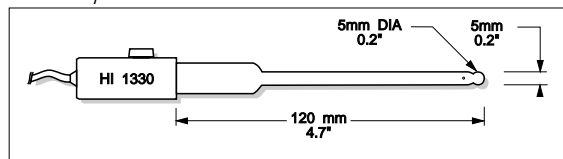

HI 1331B / HI 1311S

Glass body, semimicro, single junction, refillable, combination pH electrode.
Use: flasks.

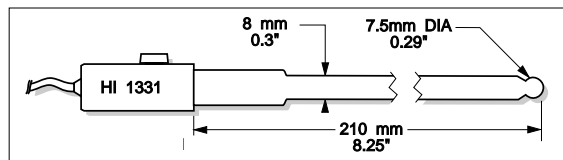

- HI 7082 3.5 M KCl electrolyte solution, 4 x 30 mL bottle, for double junction electrodes
- HI 8082 3.5 M KCl electrolyte solution, 4 x 30 mL FDA bottle, for double junction electrodes
- HI 8093 1 M KCl + AgCl electrolyte solution, 4 x 30 mL FDA bottle, for double junction electrodes

ORP SOLUTIONS

- HI 7091M Reducing pretreatment solution, 230 mL bottle
- HI 7091L Reducing pretreatment solution, 500 mL bottle
- HI 7092M Oxidizing pretreatment solution, 230 mL bottle
- HI 7092L Oxidizing pretreatment solution, 500 mL bottle
- HI 7020M Test solution @200-275 mV, 230 mL bottle
- HI 7020L Test solution @200-275 mV, 500 mL bottle
- HI 7021M Test solution @240 mV, 230 mL bottle
- HI 7021L Test solution @240 mV, 500 mL bottle
- HI 7022M Test solution @470 mV, 230 mL bottle
- HI 7022L Test solution @470 mV, 500 mL bottle

pH ELECTRODES

B = BNC CONNECTION PLUG + 1 m (3.3') CABLE

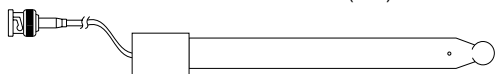

S = SCREW-TYPE CONNECTOR

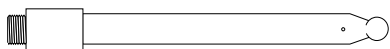

HI 1043B / HI 1040S

Glass body, double junction, refillable, combination pH electrode. Use: strong acid/alkali.

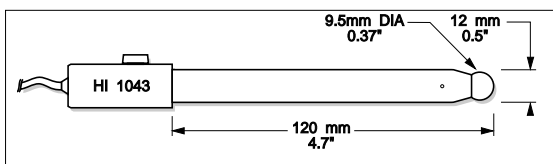

HI 1053B / HI 1050S

Glass body, triple ceramic, conic shape, refillable, combination pH electrode. Use: emulsions.

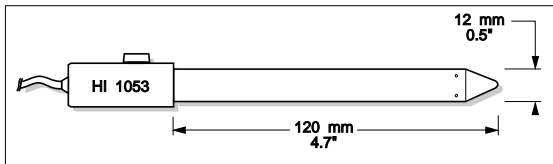

pH CALIBRATION

For better accuracy, frequent calibration of the instrument is recommended. The instrument should be recalibrated for pH:

- a) Whenever the pH electrode or temperature probe is replaced
- b) At least once a week
- c) After testing aggressive chemicals
- d) When extreme accuracy is required

PREPARATION

Pour small quantities of pH 7.01 (HI 7007) and pH 4.01 (HI 7004) or pH 10.01 (HI 7010) buffer solutions into two clean beakers.

For accurate calibration use two beakers for each buffer solution, one for rinsing the electrode tip, and one for calibration. In this way contamination of the buffers is minimized.

For measurements in acidic samples, it is recommended to calibrate the meter by using pH 7.01 (HI 7007) and pH 4.01 (HI 7004) buffers, while for alkaline measurements use pH 7.01 (HI 7007) and pH 10.01 (HI 7010) buffers.

PROCEDURE

- Connect the pH electrode and the temperature probe, then switch the meter ON.
- Remove the electrode protective cap, rinse the electrode tip with pH 7.01 solution, then immerse the pH electrode and temperature probe into pH 7.01 buffer solution; stir gently and wait a few minutes for the electrode to stabilize and reach thermal equilibrium.

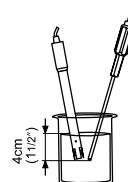

Note: The electrode should be submerged approximately 4 cm (1 1/2") into the solution. The temperature probe should be located close to the pH electrode.

- Press RANGE to display pH measurement.
- Press CAL to enter the calibration mode. The buffer value @25°C (77°F) and the "pH" symbol will blink on the display.



- The meter expects a pH 7.01 buffer.

ACCESSORIES

- When the buffer value is recognized and the reading is stable, an acoustic signal (if enabled) advises the user, the "pH" symbol stops flashing, the hourglass indicator disappears and the "CFM" tag starts blinking to indicate that the value can be confirmed.



- Press CFM to store the first calibration point.
- The meter expects a pH 4.01 or 10.01 buffer.
- Rinse and immerse the pH electrode and the temperature probe in pH 4.01 or pH 10.01 buffer (2nd calibration point) and stir gently.



- When the buffer value is recognized and the reading is stable, an acoustic signal (if enabled) advises the user, the "pH" symbol stops flashing, the hourglass indicator disappears and the "CFM" tag starts blinking to indicate that the value can be confirmed.



- Press CFM to store the second calibration point.
- The meter returns to normal mode.



The pH calibration is now complete; "CAL" and the pH tags corresponding to the buffers used for calibration are lit on the LCD.



Notes:

- If the buffer value is not recognized, after 12 seconds the meter will display blinking dashes together with the "WRONG" tag. Either the buffer solution is wrong or out of specification and needs to be replaced or the electrode is damaged.
- The meter will retain the calibration if the battery is removed.
- To quit calibration and keep previous data: press CAL after entering the calibration mode and before the first point is accepted.
- To perform a single-point calibration: press CAL after the first point has been confirmed.

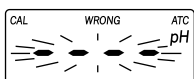

If the temperature probe is not connected and manual temperature compensation is required, follow the procedure below:

- Press RANGE to select the temperature mode.
- Rinse the pH electrode and place it into the pH 7.01 buffer, stir briefly and wait a few minutes to reach thermal equilibrium.

pH CALIBRATION SOLUTIONS

HI 70004P	pH 4.01 buffer solution, 20 mL sachet (25 pcs)
HI 7004M	pH 4.01 buffer solution, 230 mL bottle
HI 7004L	pH 4.01 buffer solution, 500 mL bottle
HI 8004L	pH 4.01 buffer solution, 500 mL FDA bottle
HI 70007P	pH 7.01 buffer solution, 20 mL sachet (25 pcs)
HI 7007M	pH 7.01 buffer solution, 230 mL bottle
HI 7007L	pH 7.01 buffer solution, 500 mL bottle
HI 8007L	pH 7.01 buffer solution, 500 mL FDA bottle
HI 70010P	pH 10.01 buffer solution, 20 mL sachet (25 pcs)
HI 7010M	pH 10.01 buffer solution, 230 mL bottle
HI 7010L	pH 10.01 buffer solution, 500 mL bottle
HI 8010L	pH 10.01 buffer solution, 500 mL FDA bottle

STORAGE & CLEANING SOLUTIONS

HI 70300M	Storage solution, 230 mL bottle
HI 80300M	Storage solution, 230 mL FDA bottle
HI 70300L	Storage solution, 500 mL bottle
HI 80300L	Storage solution, 500 mL FDA bottle
HI 70000P	Electrode rinsing solution, 20 mL sachet (25 pcs.)
HI 7061M	General cleaning solution, 230 mL bottle
HI 8061M	General cleaning solution, 230 mL FDA bottle
HI 7061L	General cleaning solution, 500 mL bottle
HI 8061L	General cleaning solution, 500 mL FDA bottle
HI 7073M	Protein cleaning solution, 230 mL bottle
HI 8073M	Protein cleaning solution, 230 mL FDA bottle
HI 7073L	Protein cleaning solution, 500 mL bottle
HI 8073L	Protein cleaning solution, 230 mL FDA bottle
HI 7074M	Inorganic cleaning solution, 230 mL bottle
HI 7074L	Inorganic cleaning solution, 500 mL bottle
HI 7077M	Oil & Fat cleaning solution, 230 mL bottle
HI 8077M	Oil & Fat cleaning solution, 230 mL FDA bottle
HI 7077L	Oil & Fat cleaning solution, 500 mL bottle
HI 8077L	Oil & Fat cleaning solution, 500 mL FDA bottle

REFILLING ELECTROLYTE SOLUTIONS

HI 7071	3.5 M KCl + AgCl electrolyte solution, 4 x 30 mL bottle, for single junction electrodes
HI 8071	3.5 M KCl + AgCl electrolyte solution, 4 x 30 mL FDA bottle, for single junction electrodes
HI 7072	1 M KNO ₃ electrolyte solution, 4 x 30 mL bottle

For refillable electrodes, if the refill solution (electrolyte) is more than 2.5 cm (1") below the fill hole, add the appropriate electrolyte solution.

MEASUREMENT

Rinse the electrode tip with distilled water, immerse it (4 cm / 1½") in the sample and stir gently for a few seconds.

For a faster response and to avoid cross contamination of the samples, rinse the electrode tip with the solution to be tested, before taking any measurements.

STORAGE PROCEDURE

To minimize clogging and ensure a quick response time, the glass bulb and the junction should always be kept moist.

When not in use, store it with a few drops of HI 70300 storage solution in the protective cap.

NEVER STORE THE ELECTRODE IN DISTILLED OR DEIONIZED WATER.

PERIODIC MAINTENANCE

Inspect electrode and cable. The cable used for the connection to the meter must be intact and there must be no points of broken insulation on the cable or cracks on the electrode stem or bulb. If any scratches or cracks are present, replace the electrode. Rinse off any salt deposits with water.

Connectors must be perfectly clean and dry.

For refillable electrodes:

Refill the electrode with fresh electrolyte (see the electrode's specifications to select the correct refilling solution). Allow the electrode to stand upright for 1 hour. Follow the Storage Procedure above.

CLEANING PROCEDURE

- *General* Soak in HI 7061 general cleaning solution for approximately 30 minutes.
- *Protein* Soak in HI 7073 protein cleaning solution for 15 min.
- *Inorganic* Soak in HI 7074 inorganic cleaning solution for 15 minutes.
- *Oil/grease* Rinse with HI 7077 Oil & Fat cleaning solution for 1 minute.

IMPORTANT: After performing any of the cleaning procedures, rinse the electrode thoroughly with distilled water and soak it in HI 70300 storage solution for at least 1 hour before taking measurements.

- Rinse the temperature probe of a **ChecktempC** (or **ChecktempF**) or another accurate thermometer, and place it close to the pH electrode.
- Use the UP and DOWN arrow keys to manually adjust the temperature to match the reference thermometer.

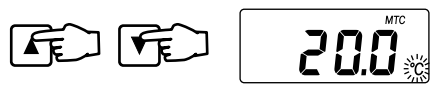

- Follow the pH calibration procedure explained in the previous pages.

pH BUFFER TEMPERATURE DEPENDENCE

The temperature has an effect on pH. The calibration buffer solutions are affected by temperature changes to a lesser degree than normal solutions. During calibration the instrument will automatically calibrate to the pH value corresponding to the measured or set temperature.

During calibration the instrument will display the pH buffer value at 25°C.

TEMP		pH VALUES		
°C	°F	4.01	7.01	10.01
0	32	4.01	7.13	10.32
5	41	4.00	7.10	10.24
10	50	4.00	7.07	10.18
15	59	4.00	7.04	10.12
20	68	4.00	7.03	10.06
25	77	4.01	7.01	10.01
30	86	4.02	7.00	9.96
35	95	4.03	6.99	9.92
40	104	4.04	6.98	9.88
45	113	4.05	6.98	9.85
50	122	4.06	6.98	9.82
55	131	4.07	6.98	9.79
60	140	4.09	6.98	9.77
65	149	4.11	6.99	9.76
70	158	4.12	6.99	9.75
75	167	4.14	7.00	9.74
80	176	4.16	7.01	9.73
85	185	4.17	7.02	9.74
90	194	4.19	7.03	9.75
95	203	4.20	7.04	9.76

MENU SELECTION

While in normal measurement mode, press and hold the CFM/SETUP key for about 5 seconds until the meter enters the menu selection mode.

The following parameters can be set from the menu:

1. Auto-off feature: 20 minutes (default setting) or disabled;
2. Acoustic signal: enabled (default setting) or disabled;
3. Temperature unit: °C (default setting) or °F.

When entering the menu mode, the auto-off selection is entered. The LCD shows in three subsequent screens "Auto", "OFF" and "20" to indicate that the 20 minutes selection is active, or "Auto", "OFF" and "no" if the feature is disabled.



The user can toggle the selection by pressing CAL/SELECT or move to the next step with CFM/SETUP.

The following selection is the acoustic signal, which is displayed on two subsequent screens: "bEEP", "OFF" when the feature is disabled, and "bEEP", "On" when the feature is enabled.

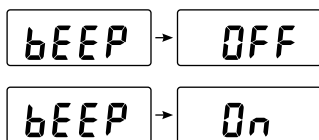

Press CAL/SELECT to toggle the selection and CFM/SETUP to move to next step. At this point it is possible to set the temperature unit, by selecting "Unit", "°C" or "Unit", "°F".

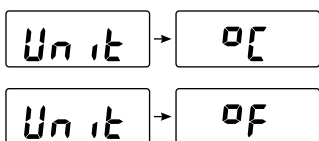

Press CAL/SELECT to toggle the selection and CFM/SETUP to exit the menu selection mode and return to normal measurement mode.

ELECTRODE CONDITIONING & MAINTENANCE

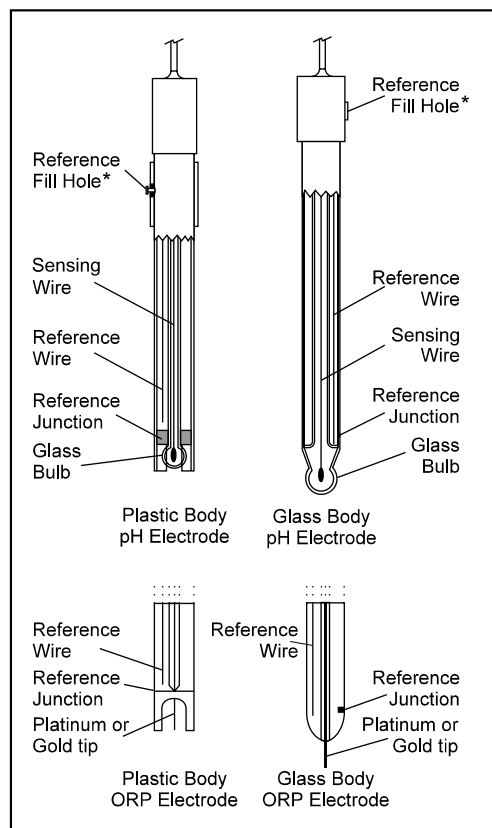

* Only for refillable electrodes; must be open while measuring.

PREPARATION PROCEDURE

Remove the electrode protective cap.

DO NOT BE ALARMED IF ANY SALT DEPOSITS ARE PRESENT. This is normal with electrodes and they will disappear when rinsed with water.

During transport tiny bubbles of air may have formed inside the glass bulb. The electrode cannot function properly under these conditions. These bubbles can be removed by "shaking down" the electrode as you would do with a glass thermometer.

If the bulb and/or junction are dry, soak the electrode in HI 70300 storage solution for at least one hour.

TROUBLESHOOTING

Symptom	Problem	Solution
Slow reponse or excessive drift	Dirty pH electrode	Soak the electrode tip in HI 7061 solution for 30 minutes
Reading fluctuates up and down (noise)	Clogged/dirty junction or low electrolyte level (refillable electrodes)	Soak the electrode tip in warm HI 7082 solution for one hour, then rinse it with distilled water (refill with fresh electrolyte if necessary)
Blinking full scale value	Reading is out of range	
Blinking "°C" (or "°F")	Temperature probe is not connected or broken	
"WRONG" & blinking dashes	Calibration error	Check buffer solution or replace pH electrode
Blinking battery symbol	Low battery level	Recharge or replace battery
Meter shuts off	Auto-off enabled or dead battery	Replace battery
"Clr" message	Loaded default pH calibration values	Perform pH calibration
"Er1" and Er2" messages	EPROM error	Contact your dealer or HANNA Service Center

Note: For field applications, it is always recommended to keep a conditioned spare electrode handy. When anomalies cannot be resolved with simple maintenance, change the electrode and recalibrate the meter.

mV CALIBRATION

HI 8424NEW has been accurately precalibrated for mV range at the factory. For optimum accuracy, it is recommended to recalibrate the meter for mV readings at least once a year.

Contact your dealer or the nearest HANNA instruments® Customer Service Center for more information.

TEMPERATURE CALIBRATION

HI 8424NEW has been accurately precalibrated for temperature at the factory. For optimum accuracy, it is recommended to recalibrate the meter for temperature at least once a year.

Contact your dealer or the nearest HANNA instruments® Customer Service Center for more information.

BATTERY RECHARGE AND REPLACEMENT

The meter displays the remaining battery percentage when turned on. When the level is below 5%, the battery symbol on the bottom left of the LCD blinks to indicate a low battery condition.



If the battery level is low enough to cause erroneous readings, the Battery Error Prevention System (BEPS) turns the meter off.

The 9V battery provided with the instrument can be recharged using the optional HI 710040 battery charger.

Plug the recharger and the green LED will turn on, then put the meter on the recharger and the LED will turn to orange, to indicate that the battery is charging.

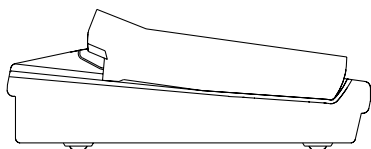

It will take approx. 14 hours to completely charge the battery.

The supplied 9V Ni-MH rechargeable battery can last for about 5 years. When the battery needs to be replaced, remove the cover on the rear of the meter and replace the rundown battery with a new one, while paying attention to the correct polarity. Reattach the back making sure that the gasket is in place and tighten the 3 screws to ensure a good seal.

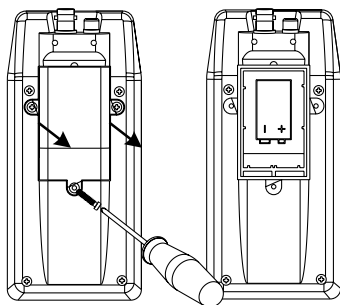

Replacement should take place in a non-hazardous area using a 9V Ni-MH rechargeable battery.

Note: The meter can also be powered with a normal 9V alkaline battery.
NEVER USE THE HI 710040 CHARGER WITH NON-RECHARGEABLE BATTERY.

Note: Dispose of the Ni-MH battery according to local regulations.

LCD MESSAGES & TROUBLESHOOTING

TAGS & SYMBOLS

- pH, mV, °C, °F Measurement unit of the selected mode
- ATC Indicates Automatic Temperature Compensation (in pH or temperature mode)
- MTC Indicates Manual Temperature Compensation (in pH or temperature mode)
- HOLD Blinks when in Hold mode. Reading frozen on LCD. The user can scroll through the three ranges by pressing RANGE
- CAL In pH calibration mode, or in pH mode when the meter is calibrated
- CFM Blinks in pH calibration mode when the meter is ready to confirm a value
- WRONG During pH calibration, when the meter does not recognize the pH buffer
- % At startup, when showing the percentage of the remaining battery life
- 7 In pH mode, when meter was calibrated with pH 7.01 buffer
- 4 In pH mode, when meter was calibrated with pH 4.01 buffer
- 10 In pH mode, when meter was calibrated with pH 10.01 buffer
- ⌚ (hourglass symbol): When reading is not stable
- 🔋 (battery symbol): At startup, if remaining battery life is below 5%