

HI5421

DO/BOD/OUR/SOUR/Temperature
Bench Meter



INSTRUCTION MANUAL

 **HANNA**[®]
instruments

Dear Customer

Thank you for choosing a Hanna Instruments product.

Please read this instruction manual carefully before using this instrument. This manual will provide you with the necessary information for correct use of this instrument, as well as a precise idea of its versatility.

If you need additional technical information, do not hesitate to e-mail us at tech@hannainst.com or view our worldwide contact list for a Hanna representative near you at www.hannainst.com.

All rights are reserved. Reproduction in whole or in part is prohibited without the written consent of the copyright owner.

PRELIMINARY EXAMINATION	4
GENERAL DESCRIPTION	5
FUNCTIONAL DESCRIPTION	6
SPECIFICATIONS	8
OPERATIONAL GUIDE	9
DISPLAYING MODES.....	10
SYSTEM SETUP	13
DO SETUP	20
BOD SETUP.....	34
OUR SETUP.....	35
SOUR SETUP	36
DO CALIBRATION	37
PRESSURECALIBRATION.....	39
DO MEASUREMENT.....	40
BOD MEASUREMENT.....	44
OUR MEASUREMENT	49
SOUR MEASUREMENT.....	50
LOGGING	51
PC INTERFACE	55
PROBE CONDITIONING AND MAINTENANCE.....	56
TROUBLESHOOTING GUIDE.....	57
ACCESSORIES.....	58

Remove the instrument from the packing material and examine it carefully to make sure that no damage has occurred during shipping. If there is any damage, notify your dealer or the nearest Hanna Service Center.

The meter is supplied complete with:

- [HI76483](#) DO probe for laboratory use with built-in temperature sensor
- [HI7041S](#) Electrolyte solution (30 mL)
- Membrane caps (2 pcs.)
- [HI76404W](#) Electrode Holder
- 12Vdc Power Adapter
- Electrode protective cap
- Instruction Manual and Quick Reference Guide
- Certificate

[HI5421-01](#) is supplied with 12 Vdc/120 Vac adapter.

[HI5421-02](#) is supplied with 12 Vdc/230 Vac adapter.

Note: Save all packing material until you are sure that the instrument works properly. Any defective item must be returned in the original packing with the supplied accessories.

HI5421 is a professional bench meter with color graphic LCD for DO, BOD, OUR, SOUR and temperature measurements.

The display viewing modes are: Basic information only, GLP information, Graph and Log History mode.

The main features of the instruments are:

- Single input channel;
- Capacitive touch keypad;
- Dedicated Help key with contextual message;
- Six measurement parameters: DO, BOD, OUR, SOUR, pressure and temperature;
- Automatic or user standard DO calibration;
- AutoHold feature to freeze the stable reading on the LCD (DO only);
- Two selectable alarm limits (for DO, BOD, OUR, SOUR);
- Three selectable logging modes: Automatic, Manual or AutoHold (DO only);
- Up to 100 logging lots for automatic or manual modes, up to 200 OUR and SOUR reports and up to 200 BOD method information entries;
- Selectable sampling period feature for automatic logging from 1 second to 180 minutes;
- GLP feature for DO;
- Online and offline graph;
- Large color backlight graphic LCD (240 x 320 pixels) with selectable color palette;
- PC interface via USB; download logged data to PC or use for Real time logging (**HI92000** PC application required);
- Profile feature: store up to ten different user setups.

HI5421 DESCRIPTION

FRONT PANEL

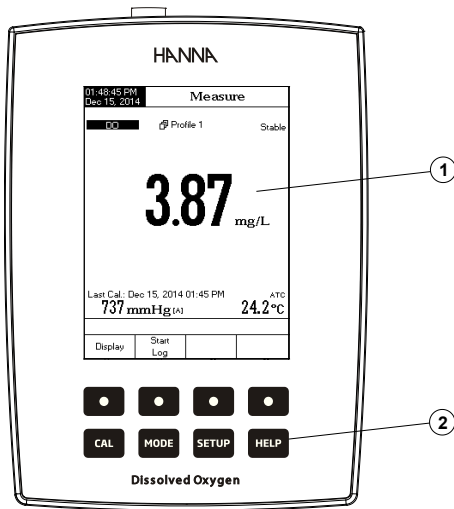

REAR PANEL

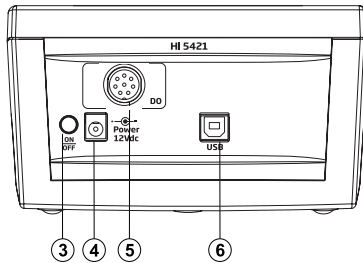

- 1) Liquid Crystal Display (LCD)
- 2) Capacitive touch keypad
- 3) ON/OFF button
- 4) Power adapter socket
- 5) DO probe input
- 6) USB connector

KEYBOARD DESCRIPTION

FUNCTION KEYS

- CAL** To enter / exit calibration mode.
- MODE** To select the desired measurement mode: DO, BOD, OUR, SOUR.
- SETUP** To enter Setup (System Setup, DO Setup, BOD Setup , OUR Setup or SOUR Setup) and to access Log Recall function.
- HELP** To obtain general informations about the selected option / operation.

VIRTUAL KEYS

The upper row keys are assigned to the **virtual keys** placed on the bottom of the LCD, which allow you to perform the displayed function, depending on the current menu (e.g. **Display** and **Start Log** in **Measure** mode).

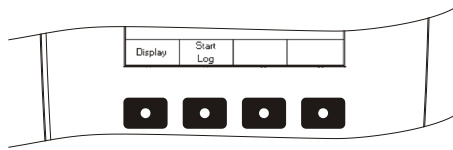

LCD GENERAL DESCRIPTION

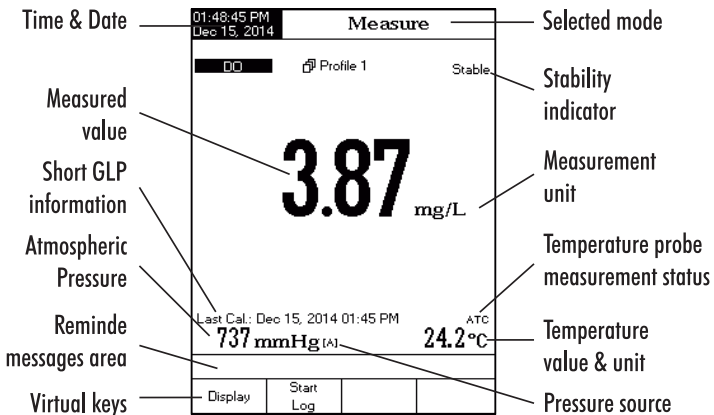

DO	Range	0.00 to 90.00 ppm (mg/L) / 0.0 to 600.0 % saturation
	Resolution	0.01 ppm (mg/L) / 0.1 % saturation
	Accuracy	± 1.5% of reading ± 1 least significant digit
Temperature	Measurement range	-20.0 to 120.0 °C / -4.0 to 248.0 °F / 253.2 to 393.2 K
	DO compensation range	0.0 to 50.0 °C / 32.0 to 122.0 °F / 237.1 to 323.1 K
	Resolution	0.1 °C / 0.1 °F / 0.1 K
	Accuracy	± 0.2 °C / ± 0.4 °F / ± 0.2 K
	Units	°C / °F / K
Barometric pressure	Range	450 to 850 mmHg / 600 to 1133 mBar / 60 to 133 kPa / 17 to 33 inHg / 8.7 to 16.4 psi / 0.592 to 1.118 atm
	Resolution	1 mmHg / 1 mBar / 1 kPa / 1 inHg / 0.1 psi / 0.001 atm
	Accuracy	± 3 mmHg ± 1 least significant digit
Salinity compensation	Range	0.0 to 70.0 % / 0.0 to 45.0 g/L / 0.0 to 42.0 psu
BOD (Biochemical Oxygen Demand)		Yes
OUR (Oxygen Uptake Rate)		Yes
SOUR (Specific Oxygen Uptake Rate)		Yes
Keyboard		8 keys capacitive touch
Probe		Polarographic with temperature built-in
PC interface		Opto-isolated USB
External Data Storage		No
Logging Features	Record samples	Up to 100 lots 50,000 records max./lot, maximum 100,000 data points 5000 samples/lot for Manual Logging
	Logging interval	14 selectable between 1 second and 180 minutes
	Type	Manual, Automatic
GLP		Last calibration data, calibration info
Backlight Saver		Yes (automatic)
AutoEnd mode		DO only
Alarm (DO, BOD, OUR, SOUR)		Yes (Inside/Outside limits)
Calibration		Automatic-two points / User standard-single point
Calibration standard		0 and 100% saturation
LCD		Color Graphic LCD 240 x 340 pixels
Dimensions		160 x 231 x 94 mm (6.3 x 9.1 x 3.7 ")
Weight		1.2 Kg (2.6 lbs)

POWER CONNECTION

Plug the 12 Vdc adapter into the power supply socket.

Note: This instrument use non volatile memory to retain the meter settings, even when unplugged.

PROBE CONNECTION

For DO, BOD, OUR or SOUR measurements connect a DO probe to the DIN connector located on the rear panel of the instrument.

INSTRUMENT START UP

- Please ensure that the capacitive keypad is not covered by hand or other objects at the meter power on.
- Turn the instrument on from the power button located on the rear panel of the instrument.
- Please wait until the instrument finishes the initialization process.

Note: It is normal for the loading process to take a few seconds. If the instrument doesn't display the next screen, restart the meter using the power button. If the problem persists, contact your dealer.



For each measurement mode (DO, BOD, OUR or SOUR) the following display configurations are available: Basic, Graph and Log History. GLP is available for DO measurements.

Basic

Accessing this option, the measured value and its units are displayed on the LCD, along with the temperature value, temperature compensation mode, pressure value, pressure compensation mode and minimal GLP data.

To choose the **Basic** displaying mode:

- Press while in **Measure** mode. The “Choose Display Configuration” message will be displayed in the Reminder messages area.
- Press . The instrument will display the basic information for the selected measurement mode.

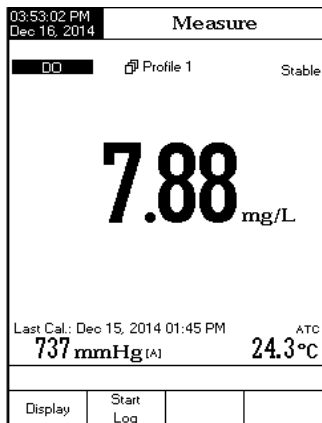

GLP

Accessing this option for DO measurement, a detailed GLP data will be displayed on the LCD: Last Calibration Date and Time, Sample ID, Calibration Standards, Barometric Pressure, Salinity, Temperature Values, the current Date and Time.

To access the **GLP** displaying mode:

- Press while in **Measure** mode. The “Choose Display Configuration” message will be displayed in the Reminder messages area.
- Press . The instrument will display the detailed GLP data.

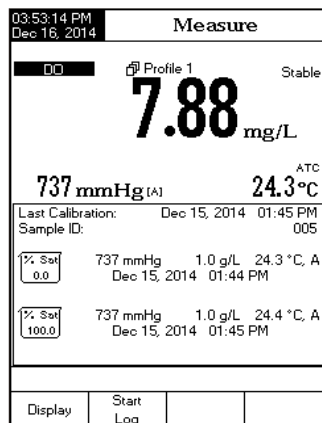

Graph

The online graph with real time logging (DO, BOD, OUR or SOUR vs. Seconds) will be displayed when this option is selected.

If there is no active log, the previously logged data for the selected parameter will be shown.

Notes: If no data is being logged, the graph will be empty.

If no automatic log is saved, the offline graph will be empty.

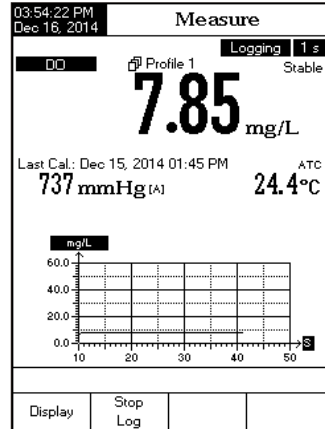

To access the **offline / online graph**:

- Press **Display** while in **Measure** mode. The “Choose Display Configuration” message will be displayed in the Reminder messages area.
- Press **Graph**
- Press **Start Log** to begin online graph.

To Zoom Graph

- Press **Display** then **Graph**, **<** and **>** will appear in virtual keys.
- Use **<** and **>** to move along the X (Time) axis of the graph.
- Press **SETUP** to access the zoom menu for Y axis. Use **Zoom IN** or **Zoom OUT** for zooming Y (parameter) axis.
- Press **Escape** to return to the main menu.

When the **offline graph** is displayed:

- Use the arrow keys to move along the X (Time) and Y (parameter) axes of the graph.
- Press **SETUP** to access the zoom menu for X and Y axes. Use **Zoom Time** or **Zoom DO** to switch between the active zooming axes. Press **Zoom IN** or **Zoom OUT** to zoom the selected axis.

*Note: While in zoom graph menu the **MODE** key is not accessible.*

- Press **Escape** to return to the main menu.

Log History

The measurement, along with Log History, will be visible when this option is selected:

- 1) The last stored logged data (Not actively logging) or
- 2) The last data logged from an active logging lot or
- 3) An empty display - NO LOTS saved, Not currently logging the log history list also contains the main measured value, the temperature, as well as a record time stamp.

To access the **Log History** displaying mode:

- Press Display while in **Measure** mode. The "Choose Display Configuration" message will be displayed in the Reminder messages area.
- Press Log History. The instrument will display the log history regarding the selected **Measure** mode.

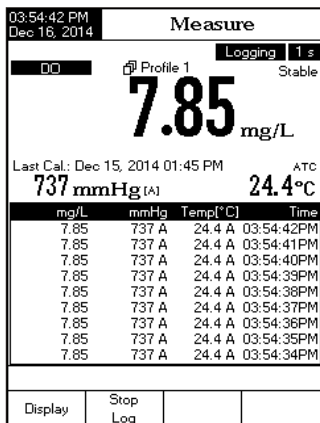

Notes: When an alarm condition is active, the logged records will have an exclamation mark "!".

If logged in Auto Hold, logged records will have an "H".

If another Measure mode is selected, the Log History will reset.

If the temperature unit is changed, all logged temperature values will be automatically displayed in the new temperature unit.

"A" denotes automatic temperature compensation.

"M" denotes manual temperature compensation.

The **System Setup** menu allows the user to customize the user interface, view meter information, set the external serial communication interface and to restore the manufacturer settings.

Accessing System Setup

- Press **SETUP** while in **Measure** mode.
- Press **System Setup**. The system setup options will be displayed on the LCD.

To access a **System Setup** option:

- Use **△** or **▽** to highlight the desired option.
- Press **Select** to access the selected option.

The following is a detailed description of the **System Setup** option screen.



Beeper

This option allows the user to turn an acoustic warning signal on or off. This function can be used to signal 4 different events: a stable signal, an alarm state, when every key is pressed or when an incorrect key is pressed. Enable (or disable) the **Beeper** for these events. Disabling the **Beeper** will stop audible signals.

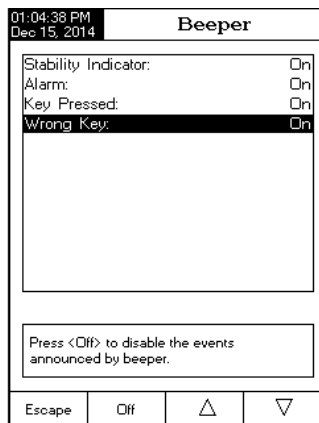

Saving Confirmation

Enable this option to force verification of a change made to a “GLP Data Option field” or a Sample ID name. If **Saving Confirmation** is enabled, the user will have to accept the change with a key stroke. If **Saving Confirmation** is disabled, the changes made to these fields change automatically without verification.

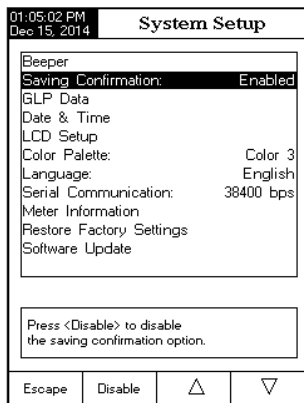

GLP Data

Use this option to customize log GLP information with specific identification data. When enabled, these ID tags will be included in the GLP section of all data logs.

Each data field can use up to 10 characters.

The five available fields are:

Operator ID : used to add the name of the operator

Instrument ID : used to name an instrument with a discrete name, location or number

Company Name : used to include the Company ID to the GLP data field.

Additional Info : two data fields are available for general notes or notations.

To add the **GLP Data**:

- Press **SETUP** while in **Measure** mode.
- Press **System Setup**.
- Use **▲** or **▼** to select the **GLP Data** option.
- Press **Select** and use **▲** or **▼** to highlight the desired option.
- Press **Select** to edit the desired information. The Text Editor menu will be displayed on the LCD.
- Enter the desired information by accepting the highlighted character which is added to the text bar, using **Select**. The **▶** and **▼** keys help the user select the desired character. It is also possible to delete the last character by positioning the cursor on the Backspace character (**⌫**) and pressing **Select**.
- Press **Escape** to return to the **GLP Data** options. If the Saving Confirmation is enabled, press **Yes** to accept the modified option, **No** to escape without saving or **Cancel** to return to the editing mode. Otherwise, the modified options are saved automatically.



Date & Time

Set the current date & time and the format in which they appear. These parameters will be displayed on the **Measure** screens and also when storing measured data.

Set Date and Time

This option allows the user to set the current date (year/month/day) and time (hour/minute/second).

Notes: Only years starting with 2000 are accepted.

The time is set using the selected time format. For 12 Hour time format only, the AM/PM can also be selected with  or .



















Set Time Format

Choose between 12-Hour (AM/PM) time format or 24-Hour time format.

Set Date Format

Choose the desired date format from 7 available options: DD/MM/YYYY; MM/DD/YYYY; YYYY/MM/DD; YYYY-MM-DD; Mon DD,YYYY; DD-Mon-YYYY or YYYY-Mon-DD.

To set the **Date & Time**:

- Press  while in **Measure** mode.
- Press .
- Use  or  to select the **Date & Time** option.
- Press  and use  or  to highlight the **Set Date and Time**.
- Press  to confirm your selection. Use  /  to select next/previous entry to be edit. Press  and use  or  to set the desired value, then press  to save the modified value (for Set Date and Time option).
- For the other two options press  to confirm your selection and select one of the displayed options.
- Press  to return to previous menu. If the Saving Confirmation is enabled, press  to accept the modified option,  to escape without saving or  to return to the editing mode. Otherwise, the modified option is saved automatically.

01:05:39 PM Dec 15, 2014		Date & Time	
Enter the date and time:			
year	month	day	
2014	12	15	
hour	minute	second	
01	05	33	PM
Press <Escape> to exit to previous screen. Press <Edit> to edit the focused entry. Press <Next> or <Previous> to select entry.			
Escape	Edit	Next	Previous

Note: If the time is changed with more than one hour before last calibration, a pop-up warning will appear on the LCD, notifying the user that a date/time conflict has occurred and some time-dependent modes could work improperly (e.g. Measure, GLP, Log).

LCD Setup

This option allows the user to set the Contrast, the Backlight of the LCD and the Backlight Saver. The Contrast parameter can be adjusted within 7 steps, while the Backlight parameter within 8 steps. The Backlight Saver can be set from 1 to 60 minutes or it can be OFF (disabled). All the changes are visible on the LCD for each parameter.

Note: If the instrument backlight turns off after the time period set, press any key to turn it back on.

To set the **LCD Setup**:

- Press **SETUP** while in **Measure** mode.
- Press **System Setup**.
- Use **Δ** or **∇** to select the **LCD Setup** option.
- Press **Select** and use **Next** key to highlight the desired parameter.
- Use **Δ** or **∇** to adjust the contrast/backlight or to set the desired backlight saver time.
- Press **Escape** to confirm the modified options and return to the System Setup menu.

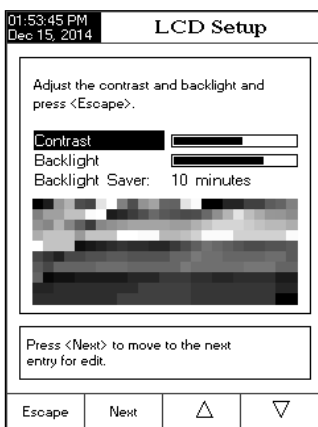

Color Palette

This option allows the user to choose a desired color palette.

To select the **Color Palette**:

- Press **SETUP** while in **Measure** mode.
- Press **System Setup**.
- Use **Δ** or **∇** to select the **Color Palette** option.
- Press **Select** and use **Δ** or **∇** to highlight the desired color.
- Press **Select** to confirm your selection and return to the System Setup menu or press **Escape** to return to the System Setup menu without changing.

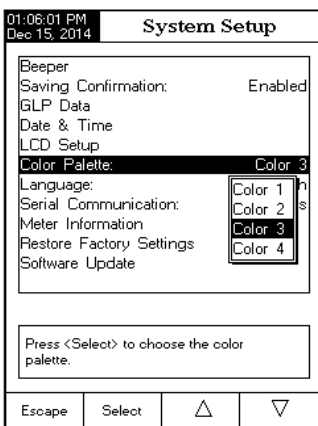

Color 1	White background blue text
Color 2	Blue background white text
Color 3	White background black text
Color 4	Black background white text

Language

This option allows the user to choose the desired language in which all informations will be displayed.

To select the **Language**:

- Press **SETUP** while in **Measure** mode.
- Press **System Setup**.
- Use **Δ** or **∇** to select the **Language** option.
- Press **Select** and use **Δ** or **∇** to highlight the desired language.
- Press **Select** to confirm your selection and return to the System Setup menu or press **Escape** to return to the System Setup menu without changing.

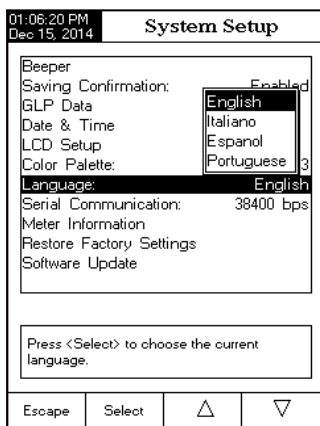

Serial Communication

This option allows the user to set the desired speed for the serial communication (baud rate) in bps. The meter and the PC program must have the same baud rate.

To set the **Serial Communication**:

- Press **SETUP** while in **Measure** mode.
- Press **System Setup**.
- Use **Δ** or **∇** to select the **Serial Communication** option.
- Press **Select** and use **Δ** or **∇** to highlight the desired baud rate.
- Press **Select** to confirm your selection and return to the System Setup menu or press **Escape** to return to the System Setup menu without changing.

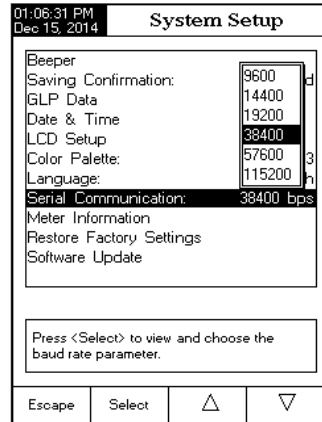

Meter Information

This option provides general information about the instrument serial number (each instrument has a unique identification serial number), the software version and the factory calibration date and time.

Note: All instruments are factory calibrated for DO, pressure and temperature. One year after factory calibration, the warning message "Factory Calibration Expired" will be displayed when powering up the instrument. The instrument will still function, however, it should be taken to the nearest Hanna Customer Service for factory calibration.

To view the **Meter Information**:

- Press **SETUP** while in **Measure** mode.
- Press **System Setup**.
- Use **Δ** or **∇** to select the **Meter Information** option.
- Press **Select** to access the **Meter Information** menu.
- Press **Escape** to return to the System Setup menu.

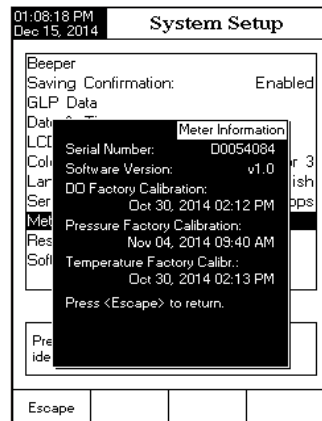

Restore Factory Settings

This option allows the user to erase all user settings and reset the instrument to the default factory settings.

To restore the **Factory Settings**:

- Press **SETUP** while in **Measure** mode.
- Press **System Setup**.
- Use **Δ** or **∇** to select the **Restore Factory Settings** option.
- Press **Select** to confirm your selection. A pop-up menu will be displayed, asking for confirmation.
- Press **Yes** to confirm your selection and return to the System Setup or press **No** to return to the System Setup menu without restoring defaults.
- Press **Escape** to return to Measure mode.



Software update

This function allows the user to update instrument software. In order to start the PC upgrade application, you need to select the proper baud rate, the software update package and start the update.

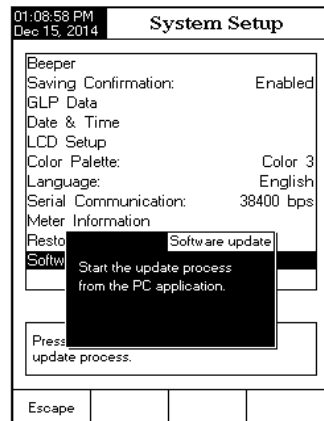

The **DO Setup** menu allows the user to set the parameters related to the DO measurement and calibration.

Accessing DO Setup

- Press **MODE** while in **Measure** mode and then **DO** to select the DO measure mode.
- Press **SETUP** and then **DO Setup** to access **DO Setup** menu.

To access a **DO setup** options:

- Use **△** or **▽** to highlight the desired option.
- Press **Select** to access the selected option or **Escape** to exit setup.

The following is a detailed description of the **DO Setup** option screens.

DO Setup			
01:10:57 PM Dec 15, 2014	Profile: Profile 1		
Reading Mode:	Direct		
Temperature Unit:	°C		
Calibration			
Measurement Unit:	mg/L		
Barometer			
Salinity			
Sample ID			
Stability Criteria:	Medium		
Log			
Alarm			
Press <Select> to access the profiles manager.			
Escape	Select	△	▽

Profile

This option opens the **Profile** manager. Enabling **Profile** allows the user to Save, Load or Delete an application **Profile**. The **Profile** option allows the user to store up to ten separate profile applications. Each **Profile** can be named and recalled at a moment's notice. A profile is a sensor setup complete with measurement units, logging and display preferences, calibration standards, setup of the Display screen for measurement (i.e. graphing, GLP) and any other sensor configuration. Once saved, the exact same profile can be used at another time. This is a handy feature if the meter is used occasionally for additional applications because it saves time in the setup of the meter and ensures the same procedure will be used.

To save the measurement configuration for DO mode:

- Press **SETUP** then **DO Setup** and use **△** or **▽** to highlight **Profile** option.
- Press **Enable** / **Disable** to enable / disable this feature.

The available options are:

Profile Feature: enable or disable the profile feature.

Save Profile: save the current profile.

Save Profile As...: save current profile using a specific name.

Load Profile: load from available profiles.

Delete Profile: delete a profile.

Save Profile

To save a profile:

- Press **SETUP** while in **DO** mode.
- Press **DO Setup**.
- Use **Δ** or **∇** to highlight Profile option.
- Press **Select** and then use **Δ** or **∇** to highlight **Save Profile**.
- Press **Select**. The existing configuration will be saved in current profile.

Save Profile As...

To create a new profile:

- Press **SETUP** while in **DO** mode.
- Press **DO Setup**.
- Use **Δ** or **∇** to highlight Profile option.
- Press **Select** and then use **Δ** or **∇** to highlight **Save Profile As...**
- Press **Select**. The Text Editor box will be displayed on the LCD.
- Enter the desired profile name by using **▶** and **∇** to highlight the desired character and then press **Select** to add it to the text bar. It is also possible to delete the last character by positioning the cursor on the Backspace character (ⓧ) and pressing **Select**.
- Press **Escape** to return to the previous menu. If the Saving Confirmation is enabled, press **Yes** to accept the modified option, **No** to escape without saving or **Cancel** to return to the editing mode. Otherwise, the modified option is saved automatically.

Note: The saved profile will automatically become the current profile.

Load Profile

To load one profile:

- Press **SETUP** while in **DO** mode.
- Press **DO Setup**.
- Use **Δ** or **∇** to highlight the Profile option.
- Press **Select** and then use **Δ** or **∇** to highlight the **Load Profile** option.

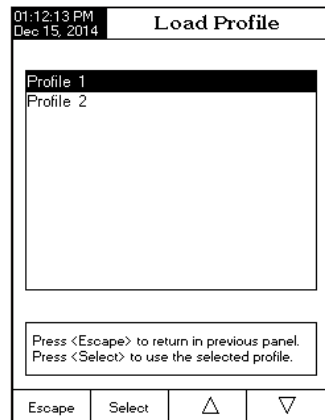
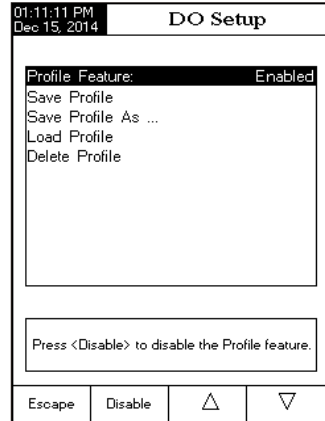

- Press **Select**. A list with all customized profiles will be displayed on the screen.
- Use **Δ** or **∇** to select the desired profile and press **Select** to confirm or **Escape** to exit without selecting.

Delete Profile

To delete one of the existing profiles:

- Use **Δ** or **∇** to highlight the **Profile** option.
- Press **Select** and then use **Δ** or **∇** to highlight the **Delete Profile** option.
- Press **Select**. A list with all customised profiles will appear on the screen.
- Use **Δ** or **∇** to select the desired profile and press **Delete**.
- Press **Escape** to return to previous menu.

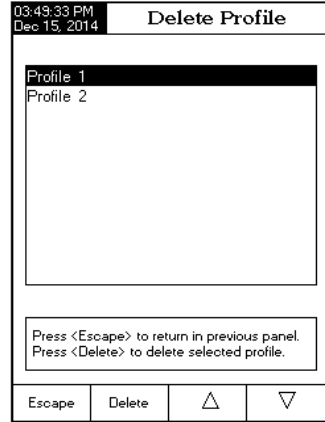

Reading Mode

This option allows the user to select between Direct or Direct/AutoHold DO reading modes.

To set the **reading mode**:

- Press **SETUP** while in **DO** mode.
- Press **DO Setup**.
- Use **Δ** or **∇** to highlight the **Reading Mode** option.
- Press **Direct** or **AutoHold** as desired.
- Press **Escape** to return to previous menu.

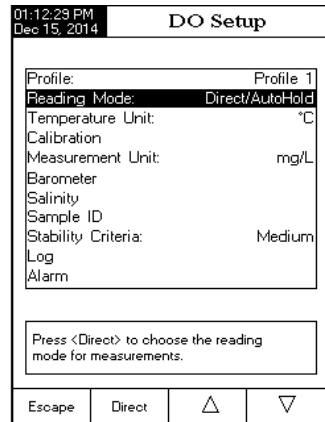

Temperature Unit

The user can choose from Celsius, Fahrenheit or Kelvin temperature units.

To set the **Temperature Unit**:

- Press **SETUP** while in **DO** mode.
- Press **DO Setup**.
- Press **Select** and then use **Δ** or **∇** to highlight the **Temperature Unit** option.
- Press **Select** and then use **Δ** or **∇** to select Celsius, Fahrenheit or Kelvin unit.
- Press **Select** to confirm your selection or press **Escape** to cancel operation.

01:12:48 PM Dec 15, 2014		DO Setup	
Profile:	Profile 1	Reading Mode:	Direct
Temperature Unit:	°C	Calibration	
Measurement Unit:	Celsius	Barometer	
Salinity	Fahrenheit	Stability Criteria:	Medium
Sample ID	Kelvin	Log	
Alarm			
Press <Select> to choose the temperature units.			
Escape	Select	Δ	∇

Calibration

This selection allows configuration of options pertaining to calibration.

Standard Recognition

The user can choose between Automatic recognition (using 2 standards) or User Standard (a single point calibration).

- Press **SETUP** while in **DO** mode.
- Press **DO Setup**.
- Use **Δ** or **∇** to highlight the **Standard Recognition** option.
- Press **Automatic** or **User Standard** as desired.
- Press **Escape** to return to previous menu.

01:16:35 PM Dec 15, 2014		DO Setup	
Standard Recognition:	Automatic	Calibration Reminder:	Disabled
Set Reminder Period		Clear Calibration	
Press <User Standard> to choose the standard recognition mode.			
Escape	User Standard	Δ	∇

Calibration Reminder

This option allows the user to set the calibration reminder as Daily, Periodic or Disabled.

To set the **calibration reminder**:

- Press **SETUP** while in **DO** mode.
- Press **DO Setup**.
- Use **Δ** or **∇** to highlight the Calibration option.
- Use **Δ** or **∇** to highlight the **Calibration reminder** option.
- Press **Select** to confirm your selection and then use **Δ** or **∇** to choose the desired option.
- Press **Select** to confirm your selection or press **Escape** to cancel operation.

01:16:59 PM Dec 15, 2014		DO Setup	
Standard Recognition:	Automatic		
Calibration Reminder:	Disabled		
Set Reminder Period	Daily		
Clear Calibration	Periodic		
	Disabled		
Press <Select> and arrows to schedule or disable this feature.			
Escape	Select	Δ	∇

Set Reminder Period

Daily reminder - the user can set the time from the day when the reminder is to appear.

Periodic reminder - the user can set the time from the last calibration (days, hours and minutes) after which the reminder appears.

To set the **reminder period**:

- Press **SETUP** while in **DO** mode.
- Press **DO Setup**.
- Use **Δ** or **∇** to highlight the Calibration option.
- Use **Δ** or **∇** to highlight the **Set Reminder Period** option.
- Press **Select** and use **Next** / **Previous** to select next / previous entry to be edited.
- Press **Edit** and use **Δ** or **∇** to set the desired value, then press **Accept** to save the modified value or press **Escape** to cancel operation.
- Press **Escape** to return to previous menu.

01:17:19 PM Dec 15, 2014		Periodic Reminder	
Enter the time period that must be passed since the last calibration before the time reminder will appear.			
days	hours	minutes	
00	01	00	
Press <Escape> to exit to previous screen. Press <Edit> to edit the focused entry. Press <Next> or <Previous> to select entry.			
Escape	Edit	Next	Previous

Clear Calibration

Accessing this option, the existent DO calibration can be cleared. If the calibration is cleared a default meter calibration is used. Another sensor calibration should be performed.

To clear calibration:

- Press **SETUP** while in **DO** mode.
- Press **DO Setup**
- Use **Δ** or **∇** to highlight the Calibration option.
- Use **Δ** or **∇** to highlight the **Clear Calibration** option.
- Press **Select**. A pop-up menu will be displayed asking for confirmation (if calibration is available).
- Press **Yes** to confirm or press **No** to escape without saving and return to the Calibration options.

Measurement Unit

The user can select the desired measurement unit. The available options are: % Sat, mg/L or ppm. % Saturation is correct for any solvent measurement of dissolved oxygen. mg/L and ppm are used for concentration measurement in water only.

- Press **SETUP** while in **DO** mode.
- Press **DO Setup**
- Use **Δ** or **∇** to highlight the **Measurement Unit** option.
- Press **Select**
- Use **Δ** or **∇** to select % Sat or mg/L or ppm.
- Press **Select** to confirm your selection or press **Escape** to cancel operation.

01:17:40 PM Dec 15, 2014		DO Setup	
Profile:	Profile 1		
Reading Mode:	Direct		
Temperature Unit:	°C		
Calibration			
Measurement Unit:	mg/L		
Barometer	% Sat		
Salinity	mg/L		
Sample ID	ppm		
Stability Criteria:	medium		
Log			
Alarm			
Press <Select> to choose the Dissolved Oxygen measurement units.			
Escape	Select	Δ	∇

Barometer

This parameter allows configuration of parameters related to barometric pressure. This parameter is only needed when measuring in concentration units of mg/L or ppm.

From the Barometer menu the user can choose the pressure source and units, as well as the pressure.

To access a **Barometer** option:

- Press **SETUP** while in **DO** mode.
- Press **DO Setup**
- Use **△** or **▽** to highlight the **Barometer** option from the DO Setup menu.
- Press **Select** to access the Barometer option.

Pressure Source

The user can choose between Manual and Automatic pressure source. If using Automatic, the meter uses a pressure sensor located inside the meter.

To set the **pressure source**:

- Select **Automatic** or **Manual** using virtual key.
- Press **Escape** to return to previous menu.

Note: If Manual pressure source is chosen, the pressure value used to compute is set manually. If Automatic pressure source is chosen, the meter uses a measurement from the pressure sensor located in the meter. This sensor can be calibrated (see Pressure Calibration).

01:13:38 PM Dec 13, 2014		DO Setup	
Pressure Source:	Automatic		
Pressure			
Pressure Units:	mmHg		
Press <Manual> to choose the pressure source.			
Escape	Manual	△	▽

Pressure

Use to set Manual pressure value or calibrate the internal pressure sensor used when Automatic is selected under Pressure Source.

Note: Select Pressure unit first (see on the next page).

To set the **pressure**:

- Press **SETUP** while in **DO** mode.
- Press **DO Setup**
- Use **△** or **▽** to highlight the Barometer option from the DO Setup menu.
- Use **△** or **▽** to highlight the **Pressure** option.
- Press **Select** and then use **△** or **▽** to increase / decrease the value.
- Press **Escape** to save or press **Clear Cal** then **Accept** to remove previous calibration.

01:14:06 PM Dec 13, 2014		Pressure Calibration	
Edit Barometric Pressure:			
709		mmHg	
Limit Low:	450 mmHg		
Limit High:	850 mmHg		
Use <Up> and <Down> arrows to set value.			
Press <Accept> to save the current value. Press <Escape> to exit calibration mode.			
Escape	Accept	△	▽

Pressure Units

The user can choose from six pressure units: mmHg, mbar, kPa, inHg, psi or atm.

To set the **Pressure Unit**:

- Press **SETUP** while in **DO** mode.
- Press **DO Setup**.
- Use **Δ** or **▽** to highlight the Barometer option from the DO Setup menu.
- Use **Δ** or **▽** to highlight the **Pressure Units** option.
- Press **Select** and then use **Δ** or **▽** to select the desired units.
- Press **Select** to confirm your selection or press **Escape** to cancel operation.

Salinity

This parameter permits selection of measurement unit and value. Salinity Compensation is used when using DO concentration measurements (mg/L or ppm). Oxygen solubility decreases when water contains salt.

Note: Select salinity unit before setting Sample Value.

To edit the **Sample Salinity**:

- Press **SETUP** while in **DO** mode.
- Press **DO Setup**.
- Use **Δ** or **▽** to highlight the Salinity option from the DO Setup menu.
- Use **Δ** or **▽** to highlight **Salinity**.
- Press **Select** and then use **Δ** or **▽** to increase / decrease the value.
- Press **Accept** to save or press **Escape** to cancel operation.

To select **Salinity Unit**:

The user may select from three units: %, g/L or PSU.

- Use **Δ** or **▽** to highlight the Salinity option from the DO Setup menu.

01:14:48 PM
Dec 15, 2014

DO Setup

Pressure Source: Automatic
Pressure
Pressure Units: mmHg

mmHg
mbar
kPa
inHg
psi
atm

Press <Select> to change the barometric pressure units.

Escape Select Δ ▽

01:15:43 PM
Dec 15, 2014

Sample Salinity

Edit Sample Salinity:

0.0 g/L

Limit Low: 0.0 g/L
Limit High: 45.0 g/L
Use <Up> and <Down> arrows to set value.

Press <Accept> to save the current value.
Press <Escape> to exit to previous screen.

Escape Accept Δ ▽

01:16:00 PM
Dec 15, 2014







DO Setup

Salinity: 1.0
Salinity Unit: g/L

%
g/L
psu

Press <Select> to choose the salinity units.

Escape Select Δ ▽

- Use  or  to highlight the Salinity Unit option.
- Press  and then use  or  to select the desired units.
- Press  to confirm your selection or press  to cancel operation.

Sample ID











This option allows the user to assign an identification number/name to sample logs. Two Sample ID parameters are available: ID Increment mode and Edit Sample ID.

ID Increment

Choose **None** to identify a sample with a text tag.

Choose **Automatic** to identify a sample with a numeric tag. This number will be incremented by one for each new lot log but it can also be altered manually here. This number does not increment for each manual log sample. This will be automatically incremented when a New Lot is selected.

To select the **ID increment** mode:



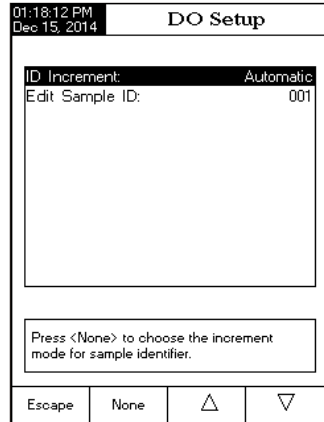

- Press  while in DO mode.
- Press .
- Use  or  to highlight the Sample ID option. Press .
- Use  or  to highlight the ID Increment option.
- Press  or  as desired.
- Press  to return to previous menu.



Edit Sample ID

This option allows the user to enter a ten character sample ID. If ID increment is None, a Text Editor screen is displayed. If ID increment is Automatic, a Numeric Editable screen is displayed.

To access the **Edit Sample ID**:

- Press  while in DO mode.
- Press .
- Use  or  to highlight **Edit Sample ID**.

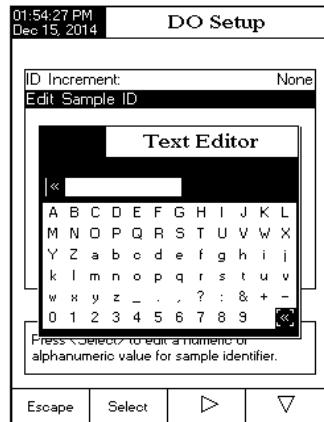

Note: ID increment is None.

- Press **Select** and use **△** or **▽** to highlight the **Edit Sample ID** option.
- Press **Select**. The Text Editor appears.
- For text editing use **▷** and **▽** to highlight the desired character and then press **Select** to add it to the text bar. It is also possible to delete the last character by positioning the cursor on the Backspace character (**⬅**) and pressing **Select**.
- Press **Escape** to return to Sample ID option. If the Saving Confirmation is enabled, press **Yes** to accept the modified option, **No** to escape without saving, or **Cancel** to return to the editing mode. Otherwise, the modified options are saved automatically.
- For numeric editing (ID Increment Automatic) use **△** or **▽** keys.
- Press **Accept** to save the current value or press **Escape** to cancel operation.

01:54:02 PM Dec 15, 2014	Edit Sample ID
Edit a numeric value for sample identifier: <div style="text-align: center; background-color: black; color: white; padding: 5px;">001</div>	
Limit Low:	001
Limit High:	999
Use <Up> and <Down> arrows to set value.	
Press <Accept> to save the current value. Press <Escape> to exit to previous screen.	
Escape	Accept
△	▽

Stability criteria

This parameter permits the user to select a signal stability criteria for the measurement. (Stable tag appears on display.)

- **Fast** - permits quicker less accurate results, the measurement may still be changing.
- **Medium**
- **Accurate** - may take longer for the Stability tag to appear but it will produce the greatest accuracy.

To select the **Stability Criteria** mode:

- Press **SETUP** while in **DO** mode.
- Press **DO Setup**.
- Use **△** or **▽** to highlight **Stability Criteria**.
- Press **Select** and use **△** or **▽** to highlight the desired option.
- Press **Accept** to save the current value or press **Escape** to cancel operation.

01:54:50 PM Dec 15, 2014	DO Setup
Profile Reading Mode: Direct Temperature Unit: °C Calibration Measurement Unit: mg/L Barometer Salinity Sample ID Stability Criteria: Medium Log Alarm	
Press <Select> to choose the stability criteria during measurement.	
Escape	Select
△	▽

Log

Note: See Logging section for available types of logging.

This option allows the user to edit the log settings: Logging Type, Logging Data Configuration, Sampling Period and New Lot.

Logging Type

Three logging types are available: Automatic, Manual and Auto Hold.

Automatic - the measurement data is logged automatically at constant time intervals.

Manual - a snapshot of the displayed measurement data is logged with time stamp when the user manually depresses Log.

Auto Hold - this is configured along with the Direct/AutoHold reading mode to take a snapshot of stable measurement data. Press to initiate a logging session. Press to initiate an Auto Hold event. The log occurs automatically once measurement stability is reached. This type log removes subjective data, as it only captures stable measurements.

To set the **Logging Type**:

- Press while in DO mode.
- Press .
- Use or to highlight the Log option.
- Press and use or to highlight the **Logging Type** option.
- Press and use or to highlight the desired option.
- Press to confirm your selection or press to cancel operation.

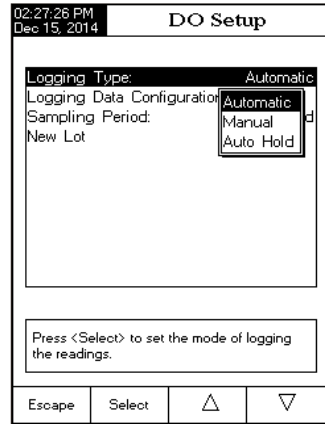

Logging Data Configuration

This option allows the user to select which parameters will accompany a log File: Date/Time, Calibration Data, Sample ID, Instrument ID, Operator ID, Company Name, Additional Info 1 and Additional Info 2.

To set the **Logging Data Configuration**:

- Press **SETUP** while in DO mode.
- Press **DO Setup**.
- Use **Δ** or **∇** to highlight the Log option.
- Press **Select** and use **Δ** or **∇** to highlight the **Logging Data Configuration** option.
- Press **Select** and use **Δ** or **∇** to highlight the desired parameter to be logged in file.
- Press **Yes** to enable the parameter or **No** to disable it.
- Press **Escape** to return to previous menu.

01:18:33 PM Dec 15, 2014		Logging Data Config.	
Date/Time:	Yes		
Calibration Data:	Yes		
Sample ID:	Yes		
Instrument ID:	Yes		
Operator ID:	Yes		
Company Name:	Yes		
Additional Info 1:	Yes		
Additional Info 2:	Yes		
Press <Yes> to enable or <No> to disable parameter.			
Escape	No	Δ	∇

Sampling Period

This option allows the user to select the desired sampling period for automatic logs.

To set the **Sampling Period**:

- Press **SETUP** while in DO mode.
- Press **DO Setup**.
- Use **Δ** or **∇** to highlight the Log option.
- Press **Select** and use **Δ** or **∇** to highlight the **Sampling Period** option.
- Press **Select** and use **Δ** or **∇** to select the desired option.
- Press **Select** to confirm your selection or press **Escape** to cancel operation.

01:18:57 PM Dec 15, 2014		DO Setup	
Logging Type:	Automatic		
Logging Data Configuration			
Sampling Period:	1 second		
New Lot			
		1 sec	
		2 sec	
		5 sec	
		10 sec	
		30 sec	
		1 min	
		2 min	
		5 min	
Press <Select> to set the sampling period for automatic logging.			
Escape	Select	Δ	∇

New Lot

This option is used to create a new lot when manual logging is used.

Note: If New Lot option is accessed and the Logging Type is Automatic, a warning message appears on the LCD informing the user that a new lot can be created only if the Logging Type is set as Manual.

To generate a **New Lot**:

- Press **SETUP** while in **DO** mode.
- Press **DO Setup**.
- Use **△** or **▽** to select the Log option.
- Press **Select** and use **△** or **▽** to highlight the **New Lot** option.
- Press **Select** to generate a new manual lot. A pop-up menu will be displayed asking for confirmation.
- Press **Yes** to confirm or press **No** to escape without saving and return to the Log options.



Alarm

This option allows the user to select the alarm settings: Alarm State and Alarm Limits. If the Alarm option is enabled, a continuous double beep will be heard, along with the "Alarm" indicator blinking on the LCD, each time the set limits in Measure mode are exceeded.

Note: Alarm Beeper must be set On for audible beep to be heard. See: System Setup → Beeper → Alarm.

Alarm State

Three settings are available for the Alarm State option:

Disabled - the alarm will be disabled.

Inside Limits - the alarm state will trigger when the measured value is inside the set limits.

Outside Limits - the alarm state will trigger when the measured value is outside the set limits.

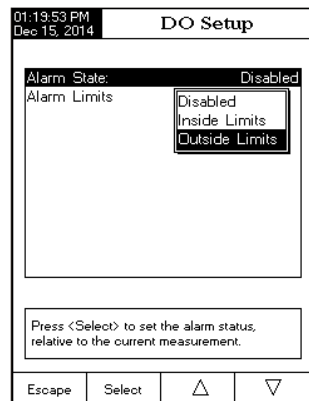

To set the **Alarm State**:

- Press **SETUP** while in **DO** mode.
- Press **DO Setup**.
- Use **Δ** or **∇** to select the Alarm option.
- Press **Select** and use **Δ** or **∇** highlight the **Alarm State** option.
- Press **Select** and use **Δ** or **∇** to highlight the desired option.
- Press **Select** to confirm your selection or press **Escape** to cancel operation.

Alarm Limits

This option allows the user to set the alarm limits for the measured value.

Note: The Alarm High value can not be lower than the Alarm Low value.

- Press **SETUP** while in **DO** mode.
- Press **DO Setup**.
- Use **Δ** or **∇** to select the Alarm option.
- Press **Select** and use **Δ** or **∇** highlight the **Alarm Limits** option.
- Press **Edit** and then use **Δ** or **∇** to set the desired value, then press **Accept** to save the modified value or press **Escape** to cancel operation.
- Press **Escape** return to the Alarm options.

03:02:05 PM Dec 15, 2014	DO Alarms		
Alarm Low: <div style="border: 1px solid black; padding: 2px; display: inline-block;">0.00</div> mg/L			
Alarm High: <div style="border: 1px solid black; padding: 2px; display: inline-block;">90.00</div> mg/L			
Press <Escape> to exit to previous screen. Press <Edit> to edit the focused entry. Press <Next> or <Previous> to select entry.			
Escape	Edit	Next	Previous

The **BOD Setup** menu allows the user to set the parameters related to the BOD measurements.

Accessing BOD Setup

A pop-up message appears to remind user to set method configuration. Press **Escape** to continue.

- Press **MODE** while in Measure mode and then **BOD** to select **BOD** mode.
- Press **SETUP** and then **BOD Setup** to access **BOD Setup** menu.

To access a **BOD Setup** option:

- Use **Δ** or **∇** to select the desired option.
- Press **Select** to confirm your selection.

The following is a description of the **BOD Setup** option screens.

Profile - see **DO Setup** section.

Temperature Unit - see **DO Setup** section.

Measurement Unit - only concentration units (mg/L or ppm) are available. See **DO Setup** section.

Method Configuration

This option allows the user to edit the BOD Method Configuration.

To edit the options:

- Press **SETUP** and then **BOD Setup** to access **BOD Setup** menu.
- Highlight the **Method Configuration** option and then press **Select**.
- Use **Next** or **Previous** to select the parameter and then press **Edit**.
- Use **Δ** or **∇** to increase / decrease the parameter value then press **Accept** to save.
- Press **Escape** to return to the previous screen.

Barometer - see **DO Setup** section.

Salinity - see **DO Setup** section.

Sample ID - see **DO Setup** section.

Log - see **DO Setup** section.

Alarm - see **DO Setup** section.

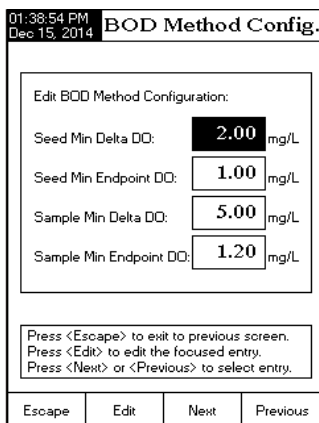
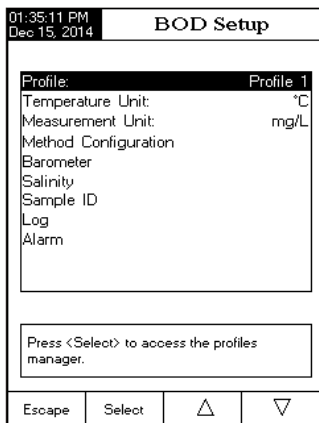

The **OUR Setup** menu allows the user to set the parameters related to the OUR measurement.

Accessing OUR Setup

- Press **MODE** while in Measure mode and then **OUR** to select OUR mode.
- A pop-up message will appear to remind user to configure the method configuration. Press **Escape** to continue.
- Press **SETUP** and then **OUR Setup** to access **OUR Setup** menu.

To access a **OUR Setup** option:

- Use **Δ** or **∇** to highlight the desired option.
- Press **Select** to access the selected option.

The following is a description of the **OUR Setup** option screens.

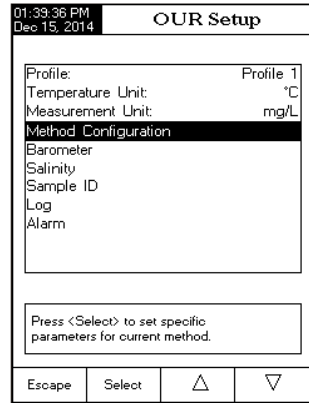

Profile - see **DO Setup** section.

Temperature Unit - see **DO Setup** section.

Measurement Unit - only concentration units are available (mg/L or ppm). See **DO Setup** section.

Method Configuration

This option allows the user to edit the OUR method configuration that will be used for calculation.

To edit the options:

- Highlight the **Method Configuration** option and then press **Select**.
- Use **Next** or **Previous** to select the parameter and then press **Edit**.
- Use **Δ** or **∇** to increase / decrease the parameter value, then press **Accept** to save the change. Use **Next** or **Previous** to move to each parameter. When finished editing select **Escape** and all changes will be saved.

Barometer - see **DO Setup** section.

Salinity - see **DO Setup** section.

Sample ID - see **DO Setup** section.

Log - see **DO Setup** section.

Alarm - see **DO Setup** section.

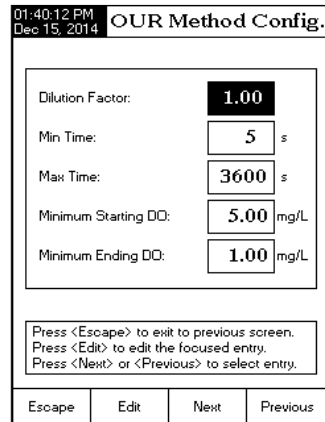

The **SOUR Setup** menu allows the user to set the parameters related to SOUR measurement.

Accessing SOUR Setup

- Press **MODE** while in Measure mode and then **SOUR** to select **SOUR** mode.
- A pop up message appears to remind user to set method configuration. Press **Escape** to continue.
- Press **SETUP** and then **SOUR Setup** to access **SOUR Setup** menu.

To access a **SOUR Setup** option:

- Use **Δ** or **∇** to highlight the desired option.
- Press **Select** to access the selected option.

The following is a description of the **SOUR Setup** options.

Profile - see **DO Setup** section.

Temperature - see **DO Setup** section.

Measurement Unit - only concentration units are available (mg/L or ppm). See **DO Setup** section.

Method Configuration

This option allows the user to edit the SOUR method configuration.

To edit the options:

- Highlight the **Method Configuration** option and then press **Select**.
- Use **Next** or **Previous** to select the parameter and then press **Edit**.
- Use **Δ** or **∇** to increase / decrease the parameter value, then press **Accept** to save the change. Use **Next** or **Previous** to move to each parameter. When finished editing select **Escape** and all changes will be saved.

Barometer - see **DO Setup** section.

Salinity - see **DO Setup** section.

Sample ID - see **DO Setup** section.

Log - see **DO Setup** section.

Alarm - see **DO Setup** section.

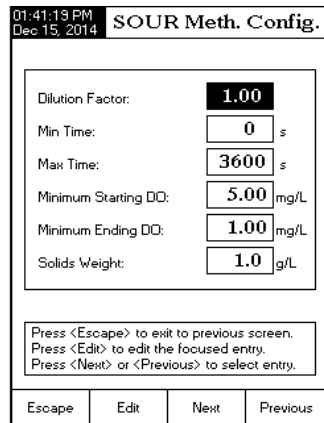
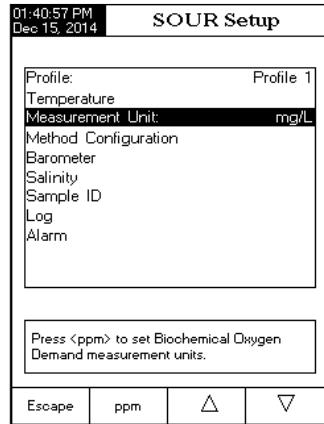

It is recommended to calibrate the probe frequently, especially if high accuracy is required.

The DO probe should be recalibrated:

- Whenever the DO probe is replaced.
- At least once a week.
- Before BOD, OUR, SOUR measurements.
- When calibration reminder is activated (“DO Cal Expired”).
- If the readings are far from the calibration point.

Note: BOD, OUR and SOUR readings are automatically derived from the DO readings. Calibrate in DO mode.

The following options are available for the Dissolved Oxygen calibration:

- Two point calibration at 100 and 0% Saturation.
- Single point at 0% Saturation.
- Single point at 100% Saturation.
- Single point user calibration using a standard value set by the user in % saturation, mg/L or ppm.

When automatic calibration is performed it is assumed that the standard value is 100% water saturated air and 0% Saturated solution.

When a user calibration is performed it is assumed that the standard value is the DO value at the current pressure, temperature and salinity.

Initial preparation

Make sure the probe is ready for measurements, i.e. the membrane is filled with electrolyte and the probe is connected to the meter and polarized.

For an accurate calibration, it is recommended to wait for at least 15 minutes to ensure precise conditioning of the probe.

Remove the protective cap from the DO probe.

Make sure the salinity value has been set to the salinity of the standard if user concentration standard is employed.

Probe conditioning

The probe is polarized with a fixed voltage of approximately 800 mV between the cathode and anode. Probe polarization is essential for stable measurements. With the probe properly polarized, oxygen is continually consumed as it passes through gas permeable PTFE membrane.

If polarization is interrupted, the electrolyte solution continues to be enriched with oxygen until it reaches an equilibrium with the surrounding solution. Whenever measurements are taken with a non-polarized probe, the measurement will be drifty and inaccurate. The measurement will jump when the probe is moved.

Note: When not in use and during polarization, use the protective transparent cap.

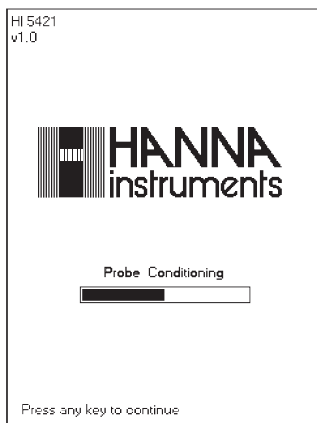

To calibrate the DO probe with meter:

When the automatic standard recognition is selected:

- Use **HI7040** Zero Oxygen solution for 0% calibration (freshly prepared).
- Rinse polarized DO probe with clean water. Dry tip and allow measurement to stabilize on meter.

Procedure:

- Suspend probe with membrane just over beaker of water for calibration in 100% Saturation.
- Press **CAL** and wait for "Stable" to appear on display. Display will be in % Saturated for calibration.
- "% Sat 100.0" should appear on display.
- Press **Accept**.
- Place probe in beaker of **HI7040** Zero Oxygen solution. "% Sat 0.0" will appear on display. Wait until "Stable" appears.
- Press **Accept**.

*Note: A single point calibration can also be made. Press **Escape** after first standard.*

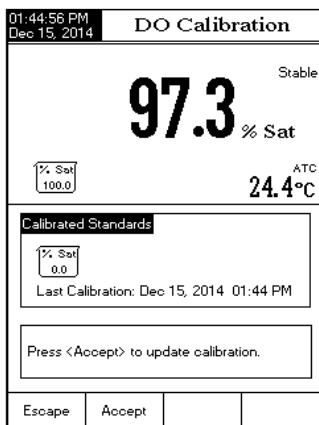

When the user standard is selected:

- The calibration can be performed at one value.
- Edit the desired standard value by using and then .
- Press again to finish the calibration or to exit calibration.

If Automatic pressure source is chosen from the Pressure Source menu (see DO Setup), a pressure calibration at one point can be performed.

To perform **pressure calibration**:

- Press to clear the current calibration;
- Use or to modify the pressure value;
- Press to finish the calibration or to exit calibration.

Note: Use a reference pressure measurement if calibrating meter's sensor.

01:46:23 PM Dec 15, 2014		Pressure Calibration	
Edit Barometric Pressure:			
737		mmHg	
Limit Low:	450 mmHg		
Limit High:	850 mmHg		
Use <Up> and <Down> arrows to set value.			
Press <Clear Cal> to clear old calibration. Press <Escape> to exit calibration mode.			
Escape	Clear Cal	<input type="button" value="Δ"/>	<input type="button" value="▽"/>

Make sure the instrument has been calibrated before taking DO measurements.

DIRECT MEASUREMENT

To measure the DO of a sample using the Direct reading mode:

- Press **MODE** and then **DO** to select DO measure mode.
- Select the *Direct* reading mode (see DO Setup).
- Submerge the DO probe and allow time for the reading to stabilize.
- The measured DO value will be displayed together with the temperature and pressure values.

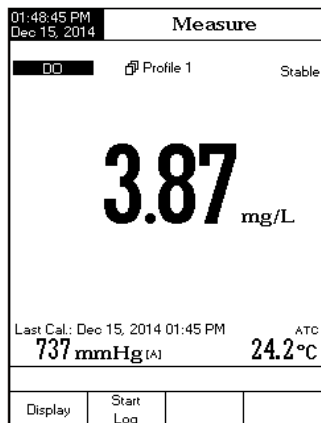

Notes: For accurate DO measurements, a water movement of 0.3 m/s is required. This is to ensure that the oxygen-depleted membrane surface is constantly replenished. A moving stream will provide adequate circulation.

If the reading is out of range, “—” will be displayed.

DIRECT/AUTOHOLD MEASUREMENT

To measure DO of a sample using the Direct/AutoHold reading mode:

- Select the **Direct/AutoHold** reading mode (see DO Setup).
- If pressing **Auto Hold**, the “AutoHold” indicator will start blinking on the display until the stability criterion is reached. The DO value will be frozen on the display, along with “AutoHold” indicator.
- To return to normal measure mode press **Continuous Reading**.

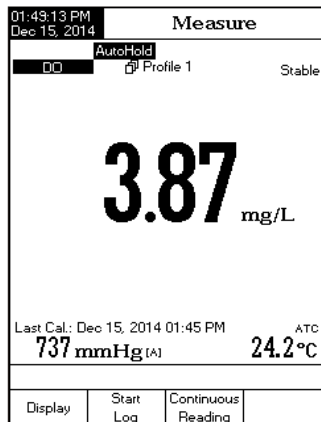

SALINITY COMPENSATION

If the sample contains significant concentration of salinity, the read out values must be corrected, taking into account the lower degree of oxygen solubility in this situation.

Before taking any DO measurements remember to set the salinity value from the DO setup menu.

The salinity affects the DO concentration, decreasing its value. The table below shows the maximum oxygen solubility at various temperatures and salinity levels.

°C	Salinity (g/l) at Sea Level					°F
	0 g/l	10 g/l	20 g/l	30 g/l	35 g/l	
0	14.60	13.64	12.74	11.90	11.50	32.0
2	13.81	12.91	12.07	11.29	10.91	36.5
4	13.09	12.25	11.47	10.73	10.38	39.2
6	12.44	11.65	10.91	10.22	9.89	42.8
8	11.83	11.09	10.40	9.75	9.44	46.4
10	11.28	10.58	9.93	9.32	9.03	50.0
12	10.77	10.11	9.50	8.92	8.65	53.6
14	10.29	9.68	9.10	8.55	8.30	57.2
16	9.86	9.28	8.73	8.21	7.97	60.8
18	9.45	8.90	8.39	7.90	7.66	64.4
20	9.08	8.56	8.07	7.60	7.38	68.0
22	8.73	8.23	7.77	7.33	7.12	71.6
24	8.40	7.93	7.49	7.07	6.87	75.2
25	8.24	7.79	7.36	6.95	6.75	77.0
26	8.09	7.65	7.23	6.83	6.64	78.8
28	7.81	7.38	6.98	6.61	6.42	82.4
30	7.54	7.14	6.75	6.39	6.22	86.0
32	7.29	6.90	6.54	6.19	6.03	89.6
34	7.05	6.68	6.33	6.01	5.85	93.2
36	6.82	6.47	6.14	5.83	5.68	96.8
38	6.61	6.28	5.96	5.66	5.51	100.4
40	6.41	6.09	5.79	5.50	5.36	104.0
42	6.22	5.93	5.63	5.35	5.22	107.6
44	6.04	5.77	5.48	5.21	5.09	111.2
46	5.87	5.61	5.33	5.07	4.97	114.8
48	5.70	5.47	5.20	4.95	4.85	118.4
50	5.54	5.33	5.07	4.83	4.75	122.0

*Note: The relationship between salinity and chlorinity for sea water is given by the equation:
Salinity (g/l) = 1.80655 Chlorinity (g/l)*

BAROMETRIC PRESSURE COMPENSATION

The dissolved oxygen saturation value varies with pressure, so it is important to compensate the effect that pressure has on DO measurements.

°C	Altitude, Meters above Sea Level																°F
	0 m	300 m	600 m	900 m	1200 m	1500 m	1800 m	2100 m	2400 m	2700 m	3000 m	3300 m	3600 m	3900 m	4000 m		
0	14.6	14.1	13.6	13.1	12.6	12.1	11.7	11.2	10.8	10.4	10.0	9.7	9.3	9.0	8.9	32.0	
2	13.8	13.3	12.8	12.4	11.9	11.5	11.0	10.6	10.2	9.9	9.5	9.2	8.8	8.5	8.4	35.6	
4	13.1	12.6	12.2	11.7	11.3	10.9	10.5	10.1	9.7	9.3	9.0	8.7	8.4	8.0	7.9	39.2	
6	12.4	12.0	11.5	11.1	10.7	10.3	9.9	9.6	9.2	8.9	8.6	8.2	7.9	7.6	7.5	42.8	
8	11.8	11.4	11.0	10.6	10.2	9.8	9.5	9.1	8.8	8.4	8.1	7.8	7.5	7.3	7.2	46.4	
10	11.3	10.9	10.5	10.1	9.7	9.4	9.0	8.7	8.4	8.1	7.8	7.5	7.2	6.9	6.8	50.0	
12	10.8	10.4	10.0	9.6	9.3	8.9	8.6	8.3	8.0	7.7	7.4	7.1	6.9	6.6	6.5	53.6	
14	10.3	9.9	9.6	9.2	8.9	8.5	8.2	7.9	7.6	7.4	7.1	6.8	6.6	6.3	6.2	57.2	
16	9.9	9.5	9.2	8.8	8.5	8.2	7.9	7.6	7.3	7.0	6.8	6.5	6.3	6.1	6.0	60.8	
18	9.5	9.1	8.8	8.5	8.1	7.8	7.6	7.3	7.0	6.8	6.5	6.3	6.0	5.8	5.7	64.4	
20	9.1	8.8	8.4	8.1	7.8	7.5	7.3	7.0	6.7	6.5	6.2	6.0	5.8	5.6	5.5	68.0	
22	8.7	8.4	8.1	7.8	7.5	7.2	7.0	6.7	6.5	6.2	6.0	5.8	5.6	5.4	5.3	71.6	
24	8.4	8.1	7.8	7.5	7.2	7.0	6.7	6.5	6.2	6.0	5.8	5.6	5.4	5.2	5.1	75.2	
25	8.3	8.0	7.7	7.4	7.1	6.8	6.6	6.4	6.1	5.9	5.7	5.5	5.3	5.1	5.0	77.0	
26	8.1	7.8	7.5	7.2	7.0	6.7	6.5	6.2	6.0	5.8	5.6	5.4	5.2	5.0	4.9	78.8	
28	7.8	7.5	7.3	7.0	6.7	6.5	6.2	6.0	5.8	5.6	5.4	5.2	5.0	4.8	4.7	82.4	
30	7.6	7.3	7.0	6.8	6.5	6.3	6.0	5.8	5.6	5.4	5.2	5.0	4.8	4.6	4.6	86.0	
32	7.3	7.0	6.8	6.5	6.3	6.1	5.8	5.6	5.4	5.2	5.0	4.8	4.7	4.5	4.4	89.6	
34	7.1	6.8	6.6	6.3	6.1	5.9	5.6	5.4	5.2	5.0	4.9	4.7	4.5	4.3	4.3	93.2	
36	6.8	6.6	6.3	6.1	5.9	5.7	5.5	5.3	5.1	4.9	4.7	4.5	4.4	4.2	4.1	96.8	
38	6.6	6.4	6.1	5.9	5.7	5.5	5.3	5.1	4.9	4.7	4.5	4.4	4.2	4.1	4.0	100.4	
40	6.4	6.2	5.9	5.7	5.5	5.3	5.1	4.9	4.7	4.6	4.4	4.2	4.1	3.9	3.9	104.4	
42	6.2	6.0	5.8	5.6	5.3	5.2	5.0	4.8	4.6	4.4	4.3	4.1	4.0	3.8	3.8	107.6	
44	6.0	5.8	5.6	5.4	5.2	5.0	4.8	4.6	4.5	4.3	4.1	4.0	3.8	3.7	3.7	111.2	
46	5.8	5.6	5.4	5.2	5.0	4.8	4.7	4.5	4.3	4.2	4.0	3.9	3.7	3.6	3.5	114.8	
48	5.7	5.5	5.3	5.1	4.9	4.7	4.5	4.4	4.2	4.0	3.9	3.7	3.6	3.5	3.4	118.4	
50	5.5	5.3	5.1	4.9	4.7	4.6	4.4	4.2	4.1	3.9	3.8	3.6	3.5	3.4	3.3	122.0	

The meter contains a built-in barometer, and it is able to automatically compensate for changes in barometric pressure. If another pressure value than the barometer's reading is to be used, then the manual pressure feature must be enabled (See DO Setup).

The table below contains a conversion altitude (m) to pressure (mmHg) for the altitude values from the previous table.

Altitude (m)	0	300	600	900	1200	1500	1800	2100	2400	2700	3000	3300	3600	3900	4000
Pressure (mmHg)	760	732	705	679	654	630	607	584	563	542	522	503	484	467	461

Biochemical oxygen demand (BOD) is an indicator for the concentration of biodegradable organic matter present in a sample of water. It can be used to determine the general quality of the water and its degree of pollution. BOD measures the rate of oxygen uptake by microorganisms in a sample of water at a fixed temperature and over a given period of time. To ensure that all other conditions are equal, a very small amount of microorganism seed is added to each sample being tested. This seed is typically generated by diluting activated sludge with deionized water. The samples are kept at 20 °C in the dark and tested for dissolved oxygen (DO) after five days. The loss of dissolved oxygen in the sample, once corrections have been made for the degree of dilution and seed addition, is called the BOD₅.

Before running a BOD measurement remember to set the BOD method configuration from the BOD setup menu and make sure the probe has been calibrated in DO mode.

Before starting the BOD procedure, calibrate the DO probe (see DO Calibration section).

- Press **MODE** and then **BOD** to select BOD measure mode.
- Press **SETUP** and then **BOD Setup**.
- Use **Δ** or **∇** to select **Method Configuration** option.
- Enter the operation limits for this method.

DAY 0 (Initial DO)

- Press **MODE** and then **BOD** followed by **Run BOD** to access the BOD management screen.

Note: The last sample analyzed will appear on the display.

- Press **Add New** to add and measure a new sample or **Add Seed** to add and measure a new seed sample.
- Press **New** then press **Add Sample**.
- A field will appear to add ID, a description, bottle volume, seed volume and sample volume.
- Place the DO probe in the sample bottle. Sample should be well mixed. Follow all standard operating procedures.
- Press **Escape**.

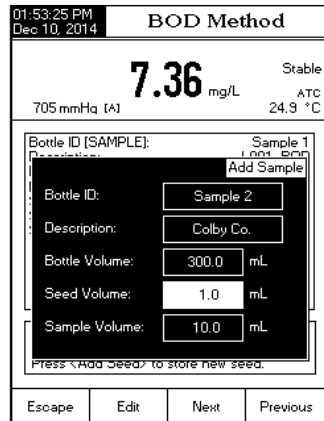

- With the probe measuring the sample press Save. The initial DO measurement will be saved.
- Remove probe from sample and fill and cover to prepare bottle for incubation.
- Rinse probe off with purified water. If desired, move probe to next sample. Press Add New and repeat this procedure on additional samples and Seed samples.
- At the conclusion of **Day 0** the probe should be cleaned and stored and all samples should be incubated following Operational Procedures.

DAY 5 (Final DO)

- Remove samples and Seed samples from the incubator for analysis.
- Press MODE then select DO. Calibrate the DO probe.
- Press MODE then select BOD.
- Press Run BOD.
- Press View Samples to access the list of the samples and seeds available. The seed records will have the symbol ****** displayed before the bottle ID.
- Select the first sample to analyze.
- Press View. The **Day 0** analysis of the sample will appear.
- Place the cleaned and calibrated DO probe into the sample selected. The exact technique should follow standard operating procedures.
- Press Evaluate BOD. The dissolved oxygen value of the sample measured is displayed.

01:57:04 PM Dec 10, 2014		BOD Method															
7.36		Stable															
705 mmHg (A)		ATC 24.9 °C															
<table style="width: 100%; border-collapse: collapse;"> <tr> <td style="width: 60%;">Bottle ID [SAMPLE]:</td> <td style="text-align: right;">Sample 2</td> </tr> <tr> <td>Description:</td> <td style="text-align: right;">Colby Co. / L002_BOD</td> </tr> <tr> <td>Initial DO:</td> <td style="text-align: right;">7.36 mg/L</td> </tr> <tr> <td>Bottle Volume:</td> <td style="text-align: right;">300.0 mL</td> </tr> <tr> <td>Seed Volume:</td> <td style="text-align: right;">1.0 mL</td> </tr> <tr> <td>Sample Volume:</td> <td style="text-align: right;">10.0 mL</td> </tr> <tr> <td>Start Time:</td> <td style="text-align: right;">Dec 10, 2014 01:56:26 PM</td> </tr> </table>				Bottle ID [SAMPLE]:	Sample 2	Description:	Colby Co. / L002_BOD	Initial DO:	7.36 mg/L	Bottle Volume:	300.0 mL	Seed Volume:	1.0 mL	Sample Volume:	10.0 mL	Start Time:	Dec 10, 2014 01:56:26 PM
Bottle ID [SAMPLE]:	Sample 2																
Description:	Colby Co. / L002_BOD																
Initial DO:	7.36 mg/L																
Bottle Volume:	300.0 mL																
Seed Volume:	1.0 mL																
Sample Volume:	10.0 mL																
Start Time:	Dec 10, 2014 01:56:26 PM																
Press <Add New> to add sample or seed. Press <View Samples> to view methods. Press <Apply BOD> to update initial DO.																	
Escape	Add New	View Samples	Apply BOD														

02:01:44 PM Dec 15, 2014		Select Bottle ID	
Sample 3	<Dec 15, 2014>		
Sample 2	<Dec 15, 2014>		
Sample 1	<Dec 15, 2014>		
*Seed 3	<Dec 15, 2014>		
*Seed 2	<Dec 15, 2014>		
*Seed 1	<Dec 15, 2014>		
Press <View> to view selected method. Press <Escape> to exit to previous screen. Press <SETUP> to change options.			
Escape	View	△	▽

01:57:35 PM Dec 10, 2014		BOD Bottle																							
<table style="width: 100%; border-collapse: collapse;"> <tr> <td style="width: 60%;">Report Name:</td> <td style="text-align: right;">L002_BOD</td> </tr> <tr> <td>Bottle ID [SAMPLE]:</td> <td style="text-align: right;">Sample 2</td> </tr> <tr> <td>Description:</td> <td style="text-align: right;">Colby Co.</td> </tr> <tr> <td>Initial DO:</td> <td style="text-align: right;">7.36 mg/L</td> </tr> <tr> <td>Bottle Volume:</td> <td style="text-align: right;">300.0 mL</td> </tr> <tr> <td>Seed Volume:</td> <td style="text-align: right;">1.0 mL</td> </tr> <tr> <td>Sample Volume:</td> <td style="text-align: right;">10.0 mL</td> </tr> <tr> <td>Temperature:</td> <td style="text-align: right;">24.9 °C, A</td> </tr> <tr> <td>Pressure:</td> <td style="text-align: right;">705 mmHg, A</td> </tr> <tr> <td>Salinity:</td> <td style="text-align: right;">4.0 ‰</td> </tr> <tr> <td>Start Time:</td> <td style="text-align: right;">Dec 10, 2014 01:56:26 PM</td> </tr> </table>				Report Name:	L002_BOD	Bottle ID [SAMPLE]:	Sample 2	Description:	Colby Co.	Initial DO:	7.36 mg/L	Bottle Volume:	300.0 mL	Seed Volume:	1.0 mL	Sample Volume:	10.0 mL	Temperature:	24.9 °C, A	Pressure:	705 mmHg, A	Salinity:	4.0 ‰	Start Time:	Dec 10, 2014 01:56:26 PM
Report Name:	L002_BOD																								
Bottle ID [SAMPLE]:	Sample 2																								
Description:	Colby Co.																								
Initial DO:	7.36 mg/L																								
Bottle Volume:	300.0 mL																								
Seed Volume:	1.0 mL																								
Sample Volume:	10.0 mL																								
Temperature:	24.9 °C, A																								
Pressure:	705 mmHg, A																								
Salinity:	4.0 ‰																								
Start Time:	Dec 10, 2014 01:56:26 PM																								
Press <Evaluate BOD> for DO measurement. Press <Escape> to exit to previous screen.																									
Escape	Evaluate BOD																								

- The Current dissolved oxygen measurement of the incubated sample will be made.

- Press to apply dilution corrections and calculate BOD.
- The message "Please wait until DO reading is stable" may appear.

Note: If , appears instead of , the incubation period was less than 24 hours and calculation will not be possible. After pressing the , the message "Repeat Initial Reading." appears. If replacing Initial BOD is required then press otherwise press .

- Remove probe from sample and rinse with purified water. Press to analyze another prepared sample or seed.

The list will reflect the 5 day analysis.

Note: No Seed correction is made in these calculations at this step. This may be made manually by subtracting the seed concentration from the samples, or made automatically with the meter (see SEED CORRECTION section).

To print a copy of the BOD analysis of the sample:

- Use [HI92000](#) software to connect the [HI5421](#) meter.
- Select BOD sample from available BOD samples.
- Press to have a paper copy of analysis.

01:58:07 PM Dec 15, 2014		BOD Method	
<h1>3.69</h1>		mg/L	ATC 24.3 °C
705 mmHg [A]			
Bottle ID [SAMPLE]: Sample 2 Description: Colby Co. / L002_BOD Initial DO: 7.36 mg/L Bottle Volume: 300.0 mL Seed Volume: 1.0 mL Sample Volume: 10.0 mL Start Time: Dec 10, 2014 01:56:26 PM			
Press <Add New> to add sample or seed. Press <View Samples> to view methods. Press <Calculate BOD> for BOD result.			
Escape	Add New	View Samples	Calculate BOD

01:58:27 PM Dec 15, 2014		BOD Method	
<h1>3.70</h1>		mg/L	Stable ATC 24.2 °C
705 mmHg [A]			
Bottle ID [SAMPLE]: Sample 2 Description: Colby Co. / L002_BOD Initial DO: 7.36 mg/L Final DO: 3.70 mg/L Bottle Volume: 300.0 mL Seed Volume: 1.0 mL Sample Volume: 10.0 mL Start Time: Dec 10, 2014 01:56:26 PM Stop Time: Dec 15, 2014 01:58:19 PM No Seed Correction			
BOD Result: 109.72 mg/L			
Press <Add New> to add sample or seed. Press <View Samples> to view methods. Press <Calculate BOD> for BOD result.			
Escape	Add New	View Samples	Calculate BOD

SEED CORRECTION

To apply seed corrections to the sample data follow the following procedure:

- Press **MODE** then **BOD** to select BOD mode.
- Press **Run BOD** and **View** to view samples.

Note: This list contains bottles with initial data, with 5 day BOD determinations and 5 day BOD determinations with seed corrections. The dates reflect the last date the sample was evaluated.

- Press **SETUP** then **BOD Results** to select the sample and seed bottles.
- If more than one Seed Bottle is used, the average value of the seeds will be used for Seed correction.

- Press **Add** to move samples into the lower box. These bottles will be corrected with the selected seed values.

02:01:44 PM
Dec 15, 2014

Select Bottle ID

Sample 3	<Dec 15, 2014>
Sample 2	<Dec 15, 2014>
Sample 1	<Dec 15, 2014>
*Seed 3	<Dec 15, 2014>
*Seed 2	<Dec 15, 2014>
*Seed 1	<Dec 15, 2014>

Press <View> to view selected method.
Press <Escape> to exit to previous screen.
Press <SETUP> to change options.

Escape	View	△	▽
--------	------	---	---

02:01:53 PM
Dec 15, 2014

Select Bottle ID

Sample 3	<Dec 15, 2014>
Sample 2	<Dec 15, 2014>
Sample 1	<Dec 15, 2014>
*Seed 3	<Dec 15, 2014>
*Seed 2	<Dec 15, 2014>
*Seed 1	<Dec 15, 2014>

Press <BOD Results> to average BOD results.
Press <View> to select view mode.
Press <Delete> or <Delete All> to delete.

BOD Results	View	Delete	Delete All
-------------	------	--------	------------

02:02:36 PM
Dec 15, 2014

BOD Select View

Available Bottle ID	
Sample 3	<Dec 15, 2014>
Sample 1	<Dec 15, 2014>
*Seed 3	<Dec 15, 2014>
*Seed 1	<Dec 15, 2014>

Selected Bottle ID	
Sample 2	<Dec 15, 2014>
*Seed 2	<Dec 15, 2014>

Press <Add> to add method to Selected ID.
Press <SETUP> to change options.
Press <MODE> for <Selected Bottle ID>.

Escape	Add	△	▽
--------	-----	---	---

- If all samples/seeds were moved to the lower box, the View Results will appear.
- Otherwise, if some of the samples/seeds were selected, press **MODE** to change soft keys. View Results will appear. Use △ / ▽ to select sample, then press View Results.

02:02:48 PM Dec 15, 2014		BOD Select View	
Available Bottle ID			
Sample 3	<Dec 15, 2014>		
Sample 1	<Dec 15, 2014>		
*Seed 3	<Dec 15, 2014>		
*Seed 1	<Dec 15, 2014>		
Selected Bottle ID			
Sample 2	<Dec 15, 2014>		
*Seed 2	<Dec 15, 2014>		
Press <View Results> to view evaluated BOD. Press <SETUP> to change options. Press <MCODE> for <Available Bottle ID>.			
Escape	View Results	△	▽

- The BOD Results with SEED correction will be displayed. Press Save to save and replace the previous sample report with this bottle ID or press Escape to keep the previous sample BOD with no seed correction.

02:08:04 PM Dec 15, 2014		BOD Results	
104.38 mg/L			
Report Name:	L002_BOD		
Bottle ID [SAMPLE]:	Sample 2		
Description:	Colby Co.		
Initial DO:	7.36 mg/L		
Final DO:	3.71 mg/L		
Bottle Volume:	300.0 mL		
Seed Volume:	1.0 mL		
Sample Volume:	10.0 mL		
Temperature:	24.2 °C A		
Pressure:	705 mmHg A		
Salinity:	4.0 ‰		
Start Time:	Dec 10, 2014 01:56:26 PM		
Stop Time:	Dec 15, 2014 02:00:51 PM		
Seed Correction:	*Seed 2		
Press <Save> to save evaluated BOD result. Press <Escape> to return in previous panel.			
Escape	Save		

To print a copy of the BOD analysis with seed correction:

- Use **HI92000** software and connect the **HI5421** meter.
- Select the BOD sample from the available BOD reports.
- Press Print to print a paper copy of the analysis.

The OUR is used to determine the oxygen consumption or respiration rate. It is defined as the mg/L of oxygen consumed per hour.

The following equation is used for OUR determination:

$$\text{OUR} = \left(\frac{\text{DO}_{\text{START}} - \text{DO}_{\text{END}}}{t_{\text{ELAPSED}}} \right) \times \left(\frac{3600 \text{ sec}}{1 \text{ h}} \right) \times \left(\frac{\text{total volume}}{\text{sample volume}} \right)$$

where:

DO_{START} = Dissolved oxygen level at start of test

DO_{END} = Dissolved oxygen level at end of test

t_{ELAPSED} = Elapsed time of test in seconds

total volume/sample volume = Dilution factor of sample

Before starting an OUR measurement remember to set the OUR configuration from the OUR setup menu and make sure the instrument has been calibrated in DO mode.

To measure the **OUR** of a sample:

- Press **MODE** and then **OUR** to select OUR measure mode.
- Place calibrated probe into sample.
- Press **Start OUR** to start taking the measurement.
- At the end of the measurement the meter will display the computed OUR value, the duration of the measurement and the pressure and temperature values.

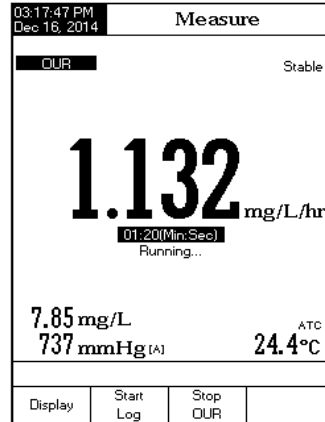

The Specific Oxygen Uptake Rate (SOUR), also known as the oxygen consumption or respiration rate, is defined as the milligram of oxygen consumed per gram of volatile suspended solids (VSS) per hour. This quick measurement has many advantages: rapid measure of influent organic load and biodegradability, indication of the presence of toxic or inhibitory wastes, degree of stability and condition of a sample, and calculation of oxygen demand rates at various points in the aeration basin. The following equation is used for SOUR determination:

$$\text{SOUR} = \text{OUR} / \text{Solids Weight}$$

where:

OUR is the Oxygen Uptake Rate

Solids Weight is the Total solids or the Volatile suspended solids weight in g/L

Temperature correction:

The SOUR value is corrected to 20 °C (68 °F) according to the Farrel and Bhide equation:

$$\text{SOUR}_{20} = \text{SOUR}_T \times \Theta^{(20 - T)}$$

Where T is the measured temperature in °C and Θ is a temperature dependent variable:

$$\Theta = 1.05 \text{ for } T \text{ above } 20\text{ }^\circ\text{C}$$

$$\Theta = 1.07 \text{ for } T \text{ below } 20\text{ }^\circ\text{C}$$

This calculation is valid only for temperature values in the range 10 to 30 °C. Temperature correction is performed only if the option **SOUR @20°C** is enabled (see Method Configuration in SOUR Setup). Before starting a SOUR measurement remember to set the SOUR configuration from the setup menu and make sure the has been calibrated in DO mode.

To measure the **SOUR** of a sample:

- Press **MODE** and then **SOUR** to select SOUR measure mode.
- Place calibrated probe into sample.
- Press **Start SOUR** to start taking the measurement.
- At the end of the measurement the meter will display the computed SOUR value, the duration of the measurement and the pressure and temperature values.



There are 5 ways the Reading Mode and Log may be configured together. The table below shows the combinations and indicates where the completed log will be stored.

Reading Mode	Log	log Recall
Direct	Automatic (1)	Automatic Log
	Manual (2)	Manual Log
	Auto Hold (NA)	Not Applicable
Direct/AutoHold	Automatic (3)	Automatic Log
	Manual (4)	Manual Log
	Auto Hold (5)	Manual Log

1) Direct Reading Mode and Automatic Log:

Real time continuous measurements are on display and continuous logs to meter memory. These are sometimes referred as interval logs. Press .

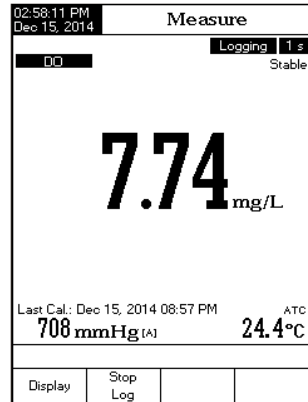

2) Direct Reading Mode and Manual Log:

Real time continuous measurements are on display and snapshots of measurement data are stored in the Manual log when the user presses . Subsequent snapshots will be added to the same Manual Lot every time the is depressed unless **New Lot** is selected under Log options.

Note: When the is pressed the lot ID along with the current record number will appear for short time on the selected channel window on the top/left corner (e.g. L001_DO 14 - this means lot ID L001_DO and record number 14).

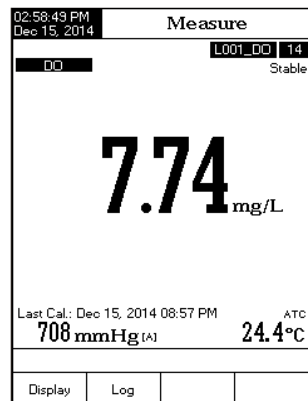

3) Direct/AutoHold Reading Mode and Automatic Log

Press **Start Log** and then **Auto Hold** keys must be pressed on front display to initiate this function. Real time continuous measurements are on display with "AutoHold" flashing and real time continuous logging into meter memory, until the meter reaches the stability criteria to go into Auto Hold mode. The stored sample logs will be marked with an "H" to indicate the Auto Hold mode. The virtual key **Continuous Reading** returns operation to real time continuous measurements and **Stop Log** stops the logging session.



4) Direct/AutoHold Reading Mode and Manual Log

Press **Log** in order to add one new record in the log report. The manual log is working even if it is in Auto Hold or Continuous reading mode. Press **Auto Hold** to initiate the Auto Hold event. "AutoHold" will flash until the stability criteria is reached and then the screen freezes in Auto Hold mode, the data is marked with an "H".

5) Direct/AutoHold Reading Mode and Auto Hold Log

Press **Start Log** and then **Auto Hold** keys to initiate and automate the capture of stable data which is stored in the Recall Manual Log file. During the process, "AutoHold" will flash until the stability criteria is reached and then the screen freezes in Auto Hold mode, the data is logged and marked with an "H". The virtual key **Continuous Reading** returns operation to Real time continuous measurement. Press **Auto Hold** again to log a second stable data point. The lot ID along with the record index will appear for short time on the top/left corner on the selected channel window, every time a record will be added to the lot.

LOG RECALL

This feature allows the user to view all stored data. If no data were logged, the "No records were found." message will be displayed on the LCD in the Log Recall screen. Otherwise, the instrument will display all the memorized lots in accordance with the selected option: Automatic Log, Manual Log or OUR/SOUR Reports.

To view the memorized data:

- Press **SETUP** while in Measure mode.
- Press **Log Recall** and then select the log report type.

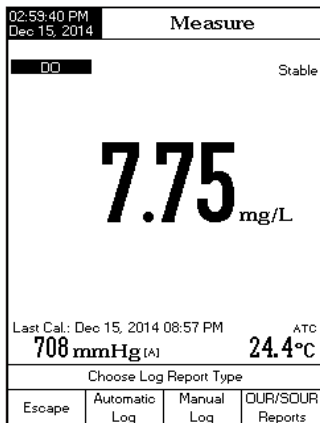

- Press **Automatic Log**, **Manual Log** or **JOURISOUR Reports** to select the desired Log Report type. All logged lots for the selected Log Report type will be displayed on the LCD.
- To filter the displayed lots, press **MODE** and then the desired parameter. Only the selected measurement parameter lots will be displayed on the LCD.
- Select the desired lot with **Δ** or **▽** and press **View** to display the logged data from the highlighted lot. The "Please wait..." message will be displayed on the LCD for one second. The selected Logging Data Configuration options will be displayed on the LCD, together with GLP information (last calibration date and calibrated standards) if a calibration has been performed on the selected mode and the logged values (measured value, temperature value, temperature compensation mode and the logging time).

Note: For automatic logging only, it is possible to view the plotted graph.

- Press **View Graph** to display the graph.
- By pressing **Shift Axes** it is possible to move the graph along the X or Y axis with the arrow keys.
- If pressing **SETUP** while the graph is displayed, the zoom menu for the X and Y axes will be accessed. Press **Zoom Time** or **Zoom DO** to switch between the active zooming axes and then zoom in or out on the selected axis by pressing the appropriate virtual key.
- Press **Escape** to return to the previous menu at any time.

03:47:00 PM
Dec 16, 2014

Auto Log Recall

L008_DO	<Dec 16, 2014	03:44:16 PM>
L005_DO	<Dec 16, 2014	03:23:23 PM>
L004_SOR	<Dec 16, 2014	03:22:44 PM>
L003_OUR	<Dec 16, 2014	03:22:37 PM>
L002_BOD	<Dec 16, 2014	03:22:28 PM>
L001_DO	<Dec 16, 2014	03:22:20 PM>

Press <View> to view selected lot.
Press <SETUP> to change options.
Press <MODE> to filter log lots.

Escape View Δ ▽

03:47:13 PM
Dec 16, 2014

Log Report

Log Lot: L008_DO
Log Type: Automatic
Company Name:
Date & Time: Dec 16, 2014 03:44:16 PM
Instrument ID:
Operator ID:
Sample ID: 005
Additional Info 1:
Additional Info 2:

Last Calibration: Dec 15, 2014 01:45PM

Calibrated Standards

Index	Standard	mg/Lg	Salinity	Temp[C]
1.	0.0 % Sat	737	1.0 g/L	24.3, A
				Dec 15, 2014 01:44:32PM
2.	2.100.0 % Sat	737	1.0 g/L	24.4, A
				Dec 15, 2014 01:45:04PM

Index	mg/L	mg/Lg	Temp[C]	Time
1	7.88	737 A	24.3 A	03:44:16PM
2	7.88	737 A	24.3 A	03:44:17PM
3	7.88	737 A	24.3 A	03:44:18PM
4	7.88	737 A	24.3 A	03:44:19PM

Escape View Graph Δ ▽

03:47:42 PM
Dec 16, 2014

Log Report

Log Lot: L008_DO
Log Type: Automatic
Company Name:
Date & Time: Dec 16, 2014 03:44:16 PM
Instrument ID:
Operator ID:
Sample ID: 005
Additional Info 1:

Graph View

Press <SETUP> to select Zoom mode

3	7.88	737 A	24.3 A	03:44:18PM
4	7.88	737 A	24.3 A	03:44:19PM

Escape Shift Axis ◀ ▶

To delete lots:

- Press **SETUP** while in Log Recall mode.
- Press **Delete** or **Delete All** to access delete or delete all mode. Otherwise, press **View** to return to Log Recall view mode.
- After selecting one of the Delete keys, use **Δ** or **▽** to select one lot and then press **Delete** or **Delete All** to delete the selected lot or all lots. The “Please wait...” message will be displayed on the LCD until the selected lot or all lots are deleted.
- Press **SETUP** and then press **View** to exit deleting mode and return to Log Recall view mode.
- Press **Escape** to exit Log Recall mode and return to Measure mode.

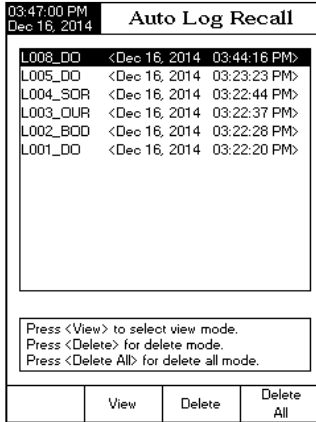

Note: Logged lots should also be deleted whenever “Limited Automatic Logging Space” or “Automatic Log Is Full” message appears on the LCD, in the Reminder messages area.

Data transmission from the instrument to the PC can be done with the [HI92000](#) Windows® compatible software (optional). [HI92000](#) also offers graphing and on-line help features.

Data logged on the [HI5421](#) meter can be exported to the most popular spreadsheet applications for further analysis.

The instrument has an USB interface.

Use a standard USB cable to connect your instrument to the PC.

Make sure that the instrument and the [HI92000](#) software have the same baud rate and the appropriate communication port.

The PC software may also be used for real time logging.

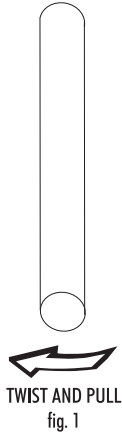

The DO probe body is made of PEI.

Use the protective cap provided when the probe is not in use. To inspect or replace the membrane proceed as follows:

Inspection:

Inspect membrane surface to ensure it is in perfect condition. The semipermeable membrane isolates the sensor elements from the environment but allows oxygen to enter. If any dirt is observed on the membrane, rinse carefully with distilled or deionized water. If imperfections still exist, or any damage is evident (such as salt crystals, wrinkles or tears-holes), the membrane should be replaced. Verify no bubbles are trapped between the cathode and membrane.

Membrane Cap Installation:

For a new probe, remove the protective shipping tube by gently twisting and pulling it off the body of the probe (see fig.1).

If a membrane cap was previously installed, unscrew the membrane cap by turning it clockwise (see fig.2).

The new membrane cap should be rinsed with electrolyte solution prior to use.

Fill the cap with clean electrolyte solution. Gently tap the sides of the membrane cap to ensure that no air bubbles remain trapped. Do not tap the bottom directly, as this will damage the membrane. Make sure that the O-Ring is seated properly inside the membrane cap (see figure). With the sensor facing down, slowly screw the membrane cap counterclockwise. Some electrolyte will overflow. When totally screwed on, verify no bubbles are found trapped in the electrolyte.

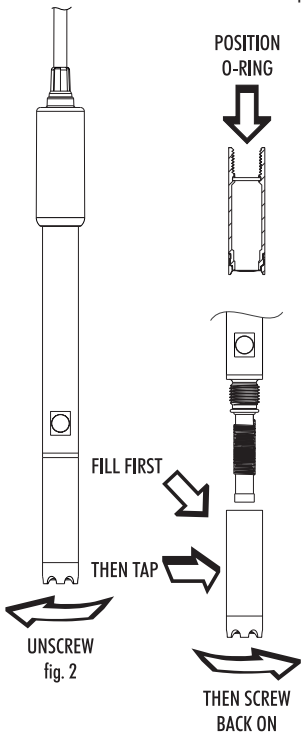

Cathode Inspection:

The platinum cathode should always be bright and untarnished. Inspect this when the cap is removed. If it is tarnished or stained, the cathode should be cleaned. Use extreme caution when handling the probe tip as the cathode insulator is glass. Inspect that the insulator has not been cracked. Use a clean lint-free cardboard or cloth. Rub the cathode very gently side to side 4-5 times. This will be enough to polish and remove any stains without damaging the platinum tip. Afterwards, rinse the probe with deionized or distilled water and install a new membrane cap using fresh electrolyte and directions above.

Conditioning:

Before proceeding with the calibration make sure the probe is ready for measurements. Reinstall the plastic protective cap over membrane end. Reconnect probe to meter and allow probe to polarize.

For an accurate calibration, it is recommended to wait a minimum of 15 minutes to ensure conditioning of the probe. Keep the protective cap on during polarization and remove it for calibration and measurements. Follow the calibration procedure.

SYMPTOMS	PROBLEM	SOLUTION
Display shows “----” during measurements.	Reading out of range.	Recalibrate the meter; Check the sample is within the measurable range.
The meter fails to calibrate or gives faulty readings.	The probe is damaged.	Replace the probe.
The instrument doesn’t measure the temperature from the probe.	The probe temperature sensor is broken.	Replace the probe.
Explicit warnings are displayed during calibration.	Dirty / damaged probe, contaminated standards.	Follow displayed instructions.
The instrument does not override the loading process.	Initialization/software error.	Restart the instrument using the power switch. If the error persists contact your vendor.
“Error Detected” pop-up at start up.	Initialization error.	Visualize the error (by pressing Yes key). Contact Hanna Technical Service if a critical error occurs.

Code	Description
HI7040L	Zero Oxygen Solution
HI7041S	Refilling Electrolyte Solution, 30 mL

OTHER ACCESSORIES

Code	Description
HI710005/8	Voltage adapter from 120 Vac / 12 Vdc 800 mA (USA plug)
HI710006/8	Voltage adapter from 230 Vac / 12 Vdc 800 mA (European plug)
HI76404W	Electrode holder
HI76483	DO probe for laboratory use with built-in temperature sensor
HI764080A/P	Spare membranes (5 pcs.)
HI92000	Windows® compatible software
HI920013	USB cable

Recommendations for Users

Before using Hanna products, make sure that they are entirely suitable for your specific application and for the environment in which they are used. Operation of these instruments may cause unacceptable interferences to other electronic equipment. Take all necessary steps to correct such interferences.

During operation, ESD wrist straps should be worn to avoid possible damage to the electrode by electrostatic discharges.

Any variation introduced by the user to the supplied equipment may degrade the instruments' EMC performance.

To avoid electrical shock, do not use these instruments when voltages at the measurement surface exceed 24 Vac or 60 Vdc.

To avoid damage or burns, do not perform any measurement in microwave ovens.

Warranty

The HI5421 is warranted for two years against defects in workmanship and materials when used for their intended purpose and maintained according to instructions. Electrodes and probes are warranted for six months. This warranty is limited to repair or replacement free of charge.

Damage due to accidents, misuse, tampering or lack of prescribed maintenance is not covered.

If service is required, contact the dealer from whom you purchased the instrument. If under warranty, report the model number, date of purchase, serial number and the nature of the problem. If the repair is not covered by the warranty, you will be notified of the charges incurred. If the instrument is to be returned to Hanna Instruments, first obtain a Returned Goods Authorization (RGA) number from the Technical Service department and then send it with shipping costs prepaid. When shipping any instrument, make sure it is properly packed for complete protection.

Hanna Instruments reserves the right to modify the design, construction or appearance of its products without advance notice.

World Headquarters

Hanna Instruments Inc.
Highland Industrial Park
584 Park East Drive
Woonsocket, RI 02895 USA
www.hannainst.com

Local Office

Hanna Instruments USA
270 George Washington Highway
Smithfield, RI 02917
Phone: 800.426.6287
Fax: 401.765.7575
e-mail: tech@hannainst.com

Local Sales and Customer Service Office



MAN5421 05/16

Printed in ROMANIA