

Instruction Manual

HI 2221 HI 2223

pH/mV/°C Bench Meters with Calibration Check

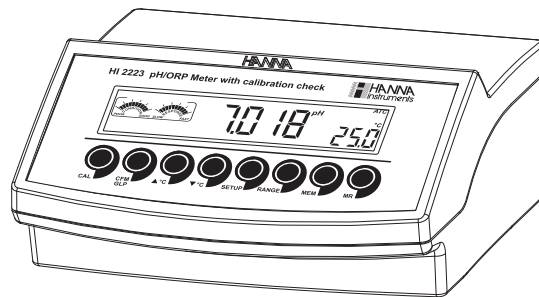

 **HANNA**[®]
instruments
www.hannainst.com

Dear Customer,
 Thank you for choosing a Hanna Instruments product.
 Please read this instruction manual carefully before using these instruments.
 This manual will provide you with the necessary information for correct use of these instruments, as well as a precise idea of their versatility.
 If you need additional technical information, do not hesitate to e-mail us at tech@hannainst.com.

WARRANTY

HI 2221 and **HI 2223** are guaranteed for two years against defects in workmanship and materials when used for their intended purpose and maintained according to instructions. The electrodes and the probes are guaranteed for a period of six months. This warranty is limited to repair or replacement free of charge.

Damage due to accidents, misuse, tampering or lack of prescribed maintenance are not covered.

If service is required, contact the dealer from whom you purchased the instrument. If under warranty, report the model number, date of purchase, serial number and the nature of the problem. If the repair is not covered by the warranty, you will be notified of the charges incurred. If the instrument is to be returned to Hanna Instruments, first obtain a Returned Goods Authorization number from the Technical Service department and then send it with shipping costs prepaid. When shipping any instrument, make sure it is properly packaged for complete protection.

TABLE OF CONTENTS

WARRANTY	2
PRELIMINARY EXAMINATION	3
GENERAL DESCRIPTION	3
FUNCTIONAL DESCRIPTION	4
HI 2221 SPECIFICATIONS	5
HI 2223 SPECIFICATIONS	6
OPERATIONAL GUIDE	7
pH CALIBRATION	9
ENHANCED CALIBRATION MESSAGES	14
ELECTRODE CONDITION & ELECTRODE RESPONSE TIME	16
pH BUFFER TEMPERATURE DEPENDENCE	17
GOOD LABORATORY PRACTICE (GLP)	18
LOGGING	21
SETUP	24
TEMPERATURE CALIBRATION (for technical personnel only)	27
mV CALIBRATION (for technical personnel only)	29
PC INTERFACE	30
ELECTRODE CONDITIONING & MAINTENANCE	34
TROUBLESHOOTING GUIDE	37
TEMPERATURE CORRELATION FOR pH SENSITIVE GLASS	38
ACCESSORIES	39
RECOMMENDATIONS FOR USERS	43

PRELIMINARY EXAMINATION

Remove the instrument from the packing material and examine it carefully to make sure that no damage has occurred during shipping. If there is any damage, notify your Dealer or the nearest Hanna Customer Service Center.

Each instrument is supplied complete with:

- **HI 1131P** Glass-body Combination pH Electrode with 1 m (3.3 ") cable
- **HI 7662** Temperature Probe
- **HI 76404N** Electrode Holder
- **pH 4.01 & 7.01** Buffer Solutions (20 mL each)
- **HI 7071** Electrolyte Solution
- 12 VDC Power Adapter
- Instruction Manual

Note: Save all packing material until you are sure that the instrument functions correctly. All defective items must be returned in the original packing with the supplied accessories.

GENERAL DESCRIPTION

HI 2221 and **HI 2223** are logging microprocessor-based pH/ORP/temperature bench meters with Calibration Check.

Calibration Check performs a set of diagnostic tests during calibration using the history of electrode slope and offset to detect problems that can cause loss of accuracy.

Calibration Check Features are:

- Enhanced Calibration Messages
During calibration the user is warned if one or more parameters are not suitable to perform an accurate calibration.
- Electrode Condition on LCD Display
Determined from the electrode offset and slope.
- Electrode response time on LCD Display
Determined from electrode performance during calibration.

Other features include: up to five pH point calibration with seven memorized buffers (1.68, 4.01, 6.86, 7.01, 9.18, 10.01 and 12.45 pH), logging up to 100 samples (for **HI 2221**) and 500 samples (for **HI 2223**), GLP, calibration due alarm, pH reading with manual or automatic temperature compensation and PC software interface.

FUNCTIONAL DESCRIPTION

Front Panel

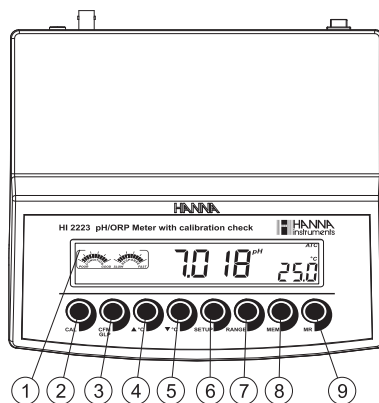

Rear Panel

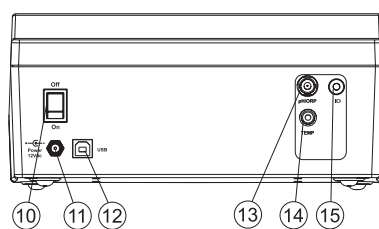

- 1) Liquid Crystal Display (LCD).
- 2) **CAL** key, to enter and exit calibration mode.
- 3) **CFM/GLP** key, to confirm calibration, different values or to display Good Laboratory Practice information.
- 4) **▲ °C** key, to manually increase temperature value or other parameters.
- 5) **▼ °C** key, to manually decrease temperature value or other parameters.
- 6) **SETUP** key, to enter/exit SETUP mode.
- 7) **RANGE** key, to select measurement range, switch to focused data in SETUP or to toggle between buffer value and temperature during calibration.
- 8) **LOG/CLR** key, to store a value into memory, to clear pH calibration, or to delete log records.
- 9) **RCL** key, memory recall.
- 10) **ON/OFF** switch.
- 11) Power supply socket.
- 12) USB connector.
- 13) BNC electrode connector.
- 14) Temperature probe socket.
- 15) Electrode reference socket.

HI 2221 SPECIFICATIONS

Range	-2.00 to 16.00 pH
	±699.9 mV ±2000 mV
	-20.0 to 120.0 °C
Resolution	0.01 pH
	0.1 mV (±699.9 mV) 1 mV (±2000 mV)
	0.1 °C
Accuracy @ 20 °C/68 °F	±0.01 pH
	±0.2 mV (±699.9 mV) ±1 mV (±2000 mV)
	±0.2 °C excluding probe error
Calibration Check	Yes
Computer Interface	Opto-isolated USB
pH Calibration	Up to 5 points, 7 buffers available (1.68, 4.01, 6.86, 7.01, 9.18, 10.01, 12.45)
Logging	100 points
Temperature Compensation	Manual or Automatic from: -20.0 to 120.0 °C (-4.0 to 248.0 °F)
pH Electrode	HI 1131P glass body, single junction refillable cell, BNC + pin (included)
Temperature Probe	HI 7662 stainless steel probe (included)
Input Impedance	10 ¹² ohm
Power Supply	12 VDC adapter (included)
Dimensions	235 x 222 x 109 mm (9.2 x 8.7 x 4.3")
Weight	1.3 Kg (2.9 lb); kit with holder 2.1 Kg (4.6 lb)
Environment	0 – 50 °C (32 – 122 °F) max RH 95 % non condensing
Warranty	2 years

HI 2223 SPECIFICATIONS

Range	-2.00 to 16.00 pH -2.000 to 16.000 pH
	±999.9 mV ±2000 mV
	-20.0 to 120.0 °C
Resolution	0.01 pH 0.001 pH
	0.1 mV (±999.9 mV) 1 mV (±2000 mV)
	0.1 °C
Accuracy @ 20 °C/68 °F	±0.01 pH ±0.002 pH
	±0.2 mV (±999.9 mV) ±1 mV (±2000 mV)
	±0.2 °C excluding probe error
Calibration Check	Yes
Computer Interface	Opto-Isolated USB
pH Calibration	Up to 5 points, 7 buffers available (1.68, 4.01, 6.86, 7.01, 9.18, 10.01, 12.45)
Logging	500 points
Temperature Compensation	Manual or Automatic from: -20.0 to 120.0 °C (-4.0 to 248.0 °F)
pH Electrode	HI 1131P glass body, single junction refillable cell, BNC + pin (included)
Temperature Probe	HI 7662 stainless steel probe (included)
Input Impedance	10 ¹² ohm
Power Supply	12 VDC adapter
Dimensions	235 x 222 x 109 mm (9.2 x 8.7 x 4.3")
Weight	1.3 Kg (2.9 lb); kit with holder 2.1 Kg (4.6 lb)
Environment	0 – 50 °C (32 – 122 °F) max RH 95 % non condensing
Warranty	2 years

OPERATIONAL GUIDE

POWER CONNECTION

Plug the 12 VDC adapter into the power supply socket.

- Notes:**
- These instruments use non volatile memory to retain the pH, mV, temperature calibrations and all other settings, even when unplugged.
 - Make sure a fuse protects the mains line.

ELECTRODE AND PROBE CONNECTIONS

For HANNA P Type pH or ORP electrodes (with internal reference) connect the electrode's BNC to the socket on the back of the instrument and the pin to the reference socket.

Note: Electrode condition and response information is displayed on the bar graph gauges during the day the calibration is performed, only if HANNA P type (PIN) electrodes are used.

If the electrode is not recognized as a HANNA P type electrode, the bar graph gauges will blink (25 seconds OFF, 4 seconds ON, full bar graph).

For temperature measurement and automatic temperature compensation connect the temperature probe to the appropriate socket.

INSTRUMENT START-UP

- Turn the instrument on by pressing the **ON/OFF** switch located on the rear panel.
- All LCD tags are displayed and a beep is sounded while the instrument performs a self test.



- The instrument will display "LoAD" message and "Σ" blinking until initialization is complete.
- The "Unscrew electrode refilling cap" message reminds the user to loosen or remove the electrode refilling cap to improve the electrode's response time.
- The instrument automatically defaults to pH measurement mode unless a HANNA P type ORP electrode is detected.

pH MEASUREMENT

Make sure the instrument has been calibrated before taking pH measurements.

- Submerge the tip of a properly conditioned electrode (see page 34) and the temperature

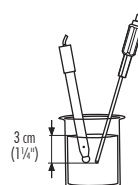

probe approximately 3 cm (1¼") into the sample to be tested and stir gently. Allow time for the electrode to stabilize.

- The pH is displayed on the primary LCD and the temperature on the secondary LCD.

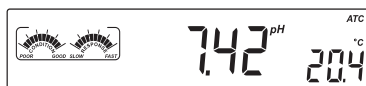

- The pH reading is out of range, the closest full-scale value will be displayed blinking on the primary LCD.
- It is also possible to view the mV reading by pressing the RANGE key.

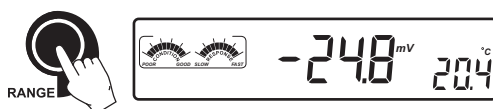

If measurements are taken successively in different samples, it is recommended to rinse the electrode thoroughly with deionized water or tap water and then with some of the next sample to prevent cross-contamination.

The pH reading is affected by temperature. In order to measure the pH accurately, this temperature effect must be compensated for. To use the Automatic Temperature Compensation feature, connect and submerge the HI 7662 temperature probe into the sample as close to the electrode as possible and wait for a few minutes.

If the temperature of the sample is known, manual compensation can be performed by disconnecting the temperature probe.



The display will show the last recorded temperature reading with the "°C" symbol blinking.



The temperature can now be adjusted with the ARROW keys (from -20.0 °C to 120.0 °C).

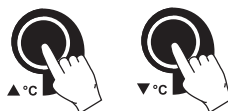

ORP MEASUREMENTS

An optional ORP electrode must be used to perform ORP measurements (see Accessories).

Oxidation-Reduction Potential (REDOX) measurements provide the quantification of the oxidizing or reducing power of the tested sample.

The surface of the ORP electrode must be clean and smooth in order to obtain an accurate measurement.

Pretreatment solutions are available to condition the electrode and speed up the response time.

- The instrument automatically defaults to the mV measurement mode if HANNA P type ORP electrode is detected.

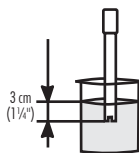

- Submerge the ORP electrode tip (3 cm/1 1/4") into the sample. Allow a few minutes for the reading to stabilize.



- The instrument displays the mV reading on the primary LCD.
- If the reading is out of range, the closest full-scale value will be displayed blinking on the primary LCD.

TAKING TEMPERATURE MEASUREMENTS

Connect the HI 7662 temperature probe and turn the instrument on. Dip the temperature probe into the sample and allow the reading on the secondary LCD to stabilize.



pH CALIBRATION

Calibrate the instrument frequently, especially if high accuracy is required. For best results and constant display of electrode condition and electrode response on the bar graph gauges, daily calibration is recommended.

The instrument should be recalibrated:

- Whenever the pH electrode is replaced.
- At least once a day.
- After testing aggressive chemicals.
- If high accuracy is required.
- If "CAL DUE" message is displayed during measurement.

Every time you calibrate the instrument use fresh buffers and perform an electrode cleaning procedure (see page 36).

PREPARATION

Pour small quantities of the buffer solutions into clean beakers. If possible, use plastic or glass beakers to minimize any EMC interferences.

For accurate calibration and to minimize cross-contamination, use two beakers for each buffer solution. One for rinsing the electrode and one for calibration.

PROCEDURE

Calibration can be performed at up to five points. For accurate measurements a three point calibration is recommended. Calibration can be performed using the seven memorized buffers:

- pH 1.68, 4.01, 6.86, 7.01, 9.18, 10.01 and 12.45.

FIVE-POINT CALIBRATION

For most applications it is recommended that pH 7.01 or 6.86 buffers be used as the first calibration point and pH 4.01 (for acidic samples) or pH 9.18/10.01 (for alkaline samples) as the second calibration point.

Note: The pH 12.45 buffer is not for general measurement; use only if the sample is very alkaline to avoid sodium error.

- Submerge the pH electrode and the temperature probe approximately 3 cm (1¼") into a buffer solution and stir gently. The temperature probe should be close to the pH electrode.
- Press the **CAL** key. "CAL" and "pH" tags will be on, and the "CLEAR CAL if new electrode" tag will blink.



- Press the **CLR** key if you are using a new electrode or want to clear the calibration history. The instrument will display the "done" message for a few seconds.
- Press the **CAL** key, or wait a few seconds to continue.



It is very important to clear the calibration history when a new electrode is used because all error and warning messages that appear during calibration depend on the calibration history.

- Note:**
- The "CLEAR CAL if new electrode" will only appear if the instrument has been previously calibrated.
 - The "CAL", "pH" and "BUFFER" tags will appear and the "7.01" buffer will be displayed on the secondary LCD.
 - If necessary, press the **ARROW** keys to select a different buffer value.
 - The "Σ" tag will blink until the reading has stabilized.



- When the reading is stable and close to the selected buffer, the “CFM” tag will blink and if enabled, an audible signal will sound.

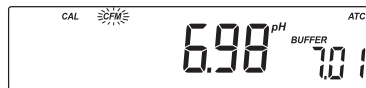

- Press the **CFM** key to confirm the calibration. The calibrated value will be displayed on the primary LCD and the second expected buffer value on the secondary LCD.



- After the first calibration point is confirmed, submerge the pH electrode and the temperature probe approximately 3 cm (1 1/4”) into the second buffer solution and stir gently. The temperature probe should be close to the pH electrode.
- If necessary, press the **ARROW** keys to select a different buffer value.

Note: The instrument will automatically skip the buffer used for the first point. It also skips 6.86 if 7.01 was used, and vice versa. Likewise, it will skip 9.18 if 10.01 has been used, and vice versa.

- The “8” tag will blink on the LCD until the reading is stable.
- When the reading is stable and close to the selected buffer the “CFM” tag will blink.
- Press **CFM** to confirm calibration.



- The calibrated value is then displayed on the primary LCD and the third expected buffer value on the secondary LCD.

- After the second calibration point is confirmed, submerge the pH electrode and the temperature probe approximately 3 cm (1 1/4”) into the next buffer solution and stir gently. The temperature probe should be close to the pH electrode.

- If necessary, press the **ARROW** keys to select a different buffer value.
- The “8” tag will blink on the LCD until the reading is stable.
- When the reading is stable and close to the selected buffer the “CFM” tag will blink.

- Press **CFM** to confirm calibration.



- After the third calibration point is confirmed, submerge the pH electrode and the temperature probe approximately 3 cm (1¼") into the next buffer solution and stir gently. The temperature probe should be close to the pH electrode.
- If necessary, press the **ARROW** keys to select a different buffer value.
- The "Σ" tag will blink on the LCD until the reading is stable.
- When the reading is stable and close to the selected buffer the "CFM" tag will blink.

- Press **CFM** to confirm calibration.

- After the fourth calibration point is confirmed, submerge the pH electrode and the temperature probe approximately 3 cm (1¼") into the next buffer solution and stir gently. The temperature probe should be close to the pH electrode.



- If necessary, press the **ARROW** keys to select a different buffer value.
- The "Σ" tag will blink on the LCD until the reading is stable.
- When the reading is stable and close to the selected buffer the "CFM" tag will blink.

- Press **CFM** to confirm calibration.

- The instrument stores the calibration value and returns to normal measurement mode.



FOUR, THREE OR TWO-POINT CALIBRATION

- Proceed as described in "FIVE-POINT CALIBRATION" section.
- Press **CAL** after the fourth, third or second calibration point was confirmed. The instrument will memorize the calibration data and return to measurement mode.

ONE-POINT CALIBRATION

Two SETUP selectable options are available: "Pnt" and "OFFS".

If the "Pnt" option is selected, the new calibration point overrides an existing one. The adjacent slopes will be reevaluated.

If the "OFFS" option is selected, an electrode offset correction is performed. The adjacent slopes will remain unchanged.

- Proceed as described in "FOUR, THREE or TWO-POINT CALIBRATION" section.
- Press **CAL** after the first calibration point was confirmed. The instrument will memorize the one-point calibration data and return to measurement mode.

- Notes:**
- To clear calibration parameters for all uncalibrated buffers starting with current buffer, press **CLR**. The calibration will continue from the current point. If this procedure is performed while calibrating in the first calibration point, the instrument returns to measurement mode.
 - Press **RANGE** to toggle between pH buffer, calibration buffer number and temperature reading.



ENHANCED CALIBRATION MESSAGES

The stored calibration history is used to issue error and warning messages during calibration to help ensure the highest accuracy.

As electrode aging is normally a slow process, substantial changes from previous calibrations are likely due to a temporary problem with the electrode or buffers.

ERROR MESSAGES

Error messages appear if one or all of the calibration parameters are out of accepted windows. Calibration can not continue when these errors are displayed.

WRONG BUFFER

This message appears when the difference between the pH reading and the value of the selected buffer is too big. If this error message is displayed, check if you have selected the proper calibration buffer.



CLEAN ELECTRODE

This error message indicates a bad electrode condition (offset out of accepted window, or slope under the accepted lower limit).

Clean the electrode according to the Cleaning Procedure on page 36 to improve its condition and repeat the calibration. This ensures the removal of film, dirt or deposits on the glass bulb and reference junction.

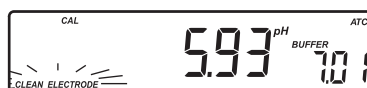

CHECK ELECTRODE alternating with CHECK BUFFER

This error message appears when electrode slope exceeds the highest accepted slope limit. You should check your electrode and use fresh buffer.

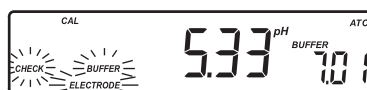

ELECTRODE

This message appears if the cleaning procedure performed as a result of the above two messages is found by the instrument to be unsuccessful.

Replace the electrode.

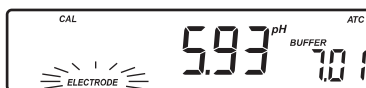

BUFFER TEMPERATURE

This message appears if the temperature of the buffer is outside the defined buffer temperature range.

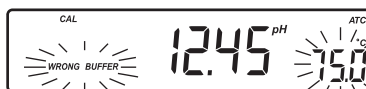

WARNING MESSAGES

During calibration, the Calibration Check feature analyzes the electrode calibration history and warns the user when problems have been detected. It is possible to over ride the warning messages and confirm the calibration but it is not recommended.

CLEAN ELECTRODE

This warning appears during Calibration Check for the second calibration buffer when the instrument has detected a small variation of offset and both offset and slope parameters. This variation may result from dirt on the electrode. Refer to the electrode cleaning procedure. This ensures the removal of film, dirt or deposits on the glass bulb and reference junction.



CLEAN ELECTRODE alternating with CHECK BUFFER

This warning appears during Calibration Check in the first calibration buffer as a result of unacceptable offset variation or in the second calibration buffer as a result of unacceptable slope variation. This variation may result from dirt on the electrode or contaminated buffer. Refer to the electrode cleaning procedure or use fresh buffer.

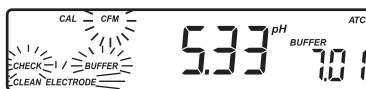

CONTAMINATED BUFFER

This warning message appears in order to alert that the buffer could be contaminated. Refresh your buffer and continue the calibration procedure.



ELECTRODE CONDITION & ELECTRODE RESPONSE TIME

When using an appropriate HANNA P Type BNC electrode with pin, HI 2221 and HI 2223 will assess electrode condition and response time during each calibration, the calibration status is displayed for the rest of the day.



The response gauge is a function of the stabilization time between the first and second calibration buffers. These gauges reflect electrode performance and should be expected to slowly decrease over the life of the electrode.

The condition gauge show the electrode's condition at the time of calibration.

For a continuous display of electrode condition and response, daily calibration is necessary. This information can also be viewed in the GLP data.

If the instrument is not calibrated, the calibration history was deleted, or it has been calibrated only at one point, the electrode condition and the electrode response gauges will be empty.

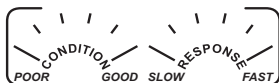

When the instrument cannot evaluate the electrode response, the response gauge will be empty (pH 1.68 or pH 12.45 were used).

If the electrode is in a very poor condition the first condition segment will blink.

If electrode response is very slow the first response segment will blink.

pH BUFFER TEMPERATURE DEPENDENCE

The temperature has an effect on pH. The calibration buffer solutions are affected by temperature changes to a lesser degree than normal solutions. During calibration the instrument will automatically calibrate to the pH value corresponding to the measured or set temperature.

TEMP		pH BUFFERS						
°C	°F	1.68	4.01	6.86	7.01	9.18	10.01	12.45
0	32	1.67	4.01	6.98	7.13	9.46	10.32	13.38
5	41	1.67	4.00	6.95	7.10	9.39	10.24	13.18
10	50	1.67	4.00	6.92	7.07	9.33	10.18	12.99
15	59	1.67	4.00	6.90	7.05	9.27	10.12	12.80
20	68	1.68	4.00	6.88	7.03	9.22	10.06	12.62
25	77	1.68	4.01	6.86	7.01	9.18	10.01	12.45
30	86	1.68	4.02	6.85	7.00	9.14	9.96	12.29
35	95	1.69	4.03	6.84	6.99	9.11	9.92	12.13
40	104	1.69	4.04	6.84	6.98	9.07	9.88	11.98
45	113	1.70	4.05	6.83	6.98	9.04	9.85	11.83
50	122	1.71	4.06	6.83	6.98	9.01	9.82	11.70
55	131	1.72	4.08	6.84	6.98	8.99	9.79	11.57
60	140	1.72	4.09	6.84	6.98	8.97	9.77	11.44
65	149	1.73	4.11	6.84	6.99	8.95	9.76	11.32
70	158	1.74	4.12	6.85	6.99	8.93	9.75	11.21
75	167	1.76	4.14	6.86	7.00	8.91	9.74	11.10
80	176	1.77	4.16	6.87	7.01	8.89	9.74	11.00
85	185	1.78	4.17	6.87	7.02	8.87	9.74	10.91
90	194	1.79	4.19	6.88	7.03	8.85	9.75	10.82
95	203	1.81	4.20	6.89	7.04	8.83	9.76	10.73

During calibration the instrument will display the pH buffer value at 25 °C.

GOOD LABORATORY PRACTICE (GLP)

GLP is a set of functions that allows the storage and retrieval of data regarding the maintenance and status of the electrode.

All data regarding the last calibration is stored for the user to review when necessary.

EXPIRED CALIBRATION

These instruments allow the user to set the number of days before the next required calibration. This value can be set from 1 to 7 days. The default setting is OFF (disabled).

The "CAL DUE" tags will blink to warn the user that the instrument should be recalibrated.

For example, if a 4 days time out has been selected, the instrument will issue the alarm exactly 4 days after the last calibration.

If the expiration value is changed (e.g. to 5 days), then the alarm will be immediately recalculated and appear 5 days after the last calibration.

- Notes:**
- If the instrument was not calibrated, or if the calibration history was deleted, the "CAL DUE" message will be displayed even if this feature is disabled in the SETUP menu.
 - If the instrument was calibrated using an electrode with pin and the electrode is changed with an electrode without pin or vice-versa "CAL DUE" will blink. This feature helps ensure use of a calibrated instrument.

pH CALIBRATION DATA

Calibration data is stored automatically after a successful calibration.

To view the pH calibration data, press the GLP key when the instrument is in pH measuring mode.

The instrument will display the time of the last calibration.

Use the **ARROW** keys to scroll through the calibration data:

- The time (hh:mm).



- The date (yyyy / mm.dd).



- The pH calibration offset.



- The pH calibration slope in mV/pH normalized to 25 °C (the percentage is referred to the ideal value of 59.16 mV/pH).



Note: If you calibrate using electrodes with pin the electrode condition and response gauges appear while the offset and slope are displayed.

- The pH calibration buffers in calibrating order and with the selected resolutions used during calibration.

The first pH calibration buffer:



The second pH calibration buffer:



The third pH calibration buffer:



The fourth pH calibration buffer:



The fifth pH calibration buffer:



Note: The "OLD" message displayed beside the pH value means that this buffer was not used during last calibration. Press and hold down **SETUP** if you want to see calibration date (or time, if old calibration was performed on the same day as the current calibration).

- If “no bUF” message appears on the LCD, the instrument informs you that the calibration was performed with less than five buffers.



- Calibration Expiration status:
 - if disabled.



- or the number of days until the calibration alarm will be displayed,



- or if expired (7 days ago).

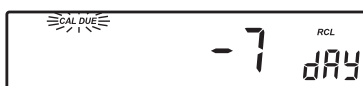

- The instrument ID.



- Notes:**
- Press GLP to return to measurement mode.
 - If calibration has not been performed, the instruments display “no CAL” message blinking.



LOGGING

Up to 100 (HI 2221) or 500 (HI 2223) logged samples can be stored in memory.

LOGGING THE CURRENT DATA

To store the current reading into memory press the LOG key while in measuring mode.

The instrument will display the current date (mm.dd) on the primary LCD, the record number on the secondary LCD and the "LOG" tag will blink for a few seconds (see example below: record No. 27 dated July 14):



If there are less than 5 memory locations remaining, the record number and the "Lo" message will be displayed to alert the user.



If the log space is full, the "FULL LOG" message will be displayed and no more data will be saved.



Along with the current measurement, the date, time, mV value, temperature and calibration data is stored. If a HANNA P Type ORP electrode is used pH information is not stored.

VIEW LOGGED DATA

Press RCL while in measurement mode to retrieve the stored information.

If no data was logged, the instrument displays:



The instrument will display the logged measurement value on the primary LCD and the record number on the secondary LCD, along with the "LOG" and "RCL" tags.

Note: The "LOG" and "RCL" tags remain on LCD while in memory recall mode.

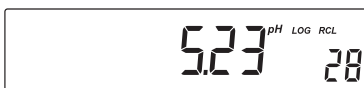

Press the **RCL** key to return to measurement mode.

Use the **ARROW** keys to scroll through the stored records:



Press the **RANGE** key to view additional data:

- The **mV** value on the primary LCD and the **temperature** on the secondary LCD.



- The **year** on the primary LCD and the **month and day** on the secondary LCD.



- The **hour and minutes** on the primary LCD and the **record number** on the secondary LCD.



- The calibration **offset** on the primary LCD and the "oFFS" message on the secondary LCD.

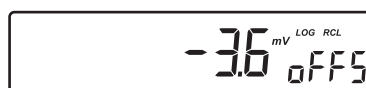

- The calibration **slope** on the primary LCD and the "SLoP" message on the secondary LCD.



Note: On the screens where record number is not displayed press the **SETUP** key to display the record number.

- To delete records press **CLR** key. The "dEL" message will be displayed on the primary LCD and the selected record on the secondary LCD. The "CFM" and the "DEL" tags will blink:



Press the **ARROW** keys to change the selected record.

To delete all records press the **SETUP** key, "ALL" tag will appear on the secondary LCD.



Press the **CFM** key to confirm the deleting of the selected record, or all records. Instrument will display on the primary LCD the "nuLL" message.



- Notes:**
- The **RANGE** key has no effect if "nuLL" record message is displayed on the first LCD line.
 - You can skip this message by selecting an undeleted record using the **ARROW** keys.
 - The instrument optimizes the usage of the memory when it returns to measurement mode after a deleting operation is performed. This will change the record numbers of logged data. During this operation the "Σ" tag will blink.
 - If all the records are deleted the instrument returns to the measuring mode.
 - After the **LOG** key is pressed or "dEL" is confirmed the instrument will display the amount of free log space for about one second (example: 25 records free).

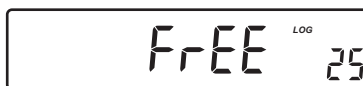

SETUP

Setup mode allows viewing and modification of the following parameters:

- Calibration Expiration Alarm
- One-point Calibration Behavior
- pH Resolution (HI 2223 only)
- Current Time (hour & minute)
- Current Date (year, month & day)
- Beep Status
- Instrument ID
- Temperature Unit

To enter the Setup mode press the **SETUP** key while the instrument is in measuring mode. Press **SETUP** key to exit SETUP mode.

Select a parameter with the **ARROW** keys.

Press the **CAL** key to change a parameter value. The selected parameter will start blinking.

Press the **RANGE** key to toggle between the displayed parameters.

Press the **ARROW** keys to increase or decrease the displayed value.

Press the **CFM** key to save the modified value or the **CAL** key to escape without saving.

Press the **ARROW** keys to select the next/previous parameter.

CALIBRATION EXPIRATION ALARM

Press the **CAL** key when the calibration expiration is displayed. Calibration time out ("OFF" or "1" to "7" days) will begin blinking.



Press the **ARROW** keys to change the calibration expiration value.

Press the **CFM** key to save the modified calibration expiration value or press the **CAL** key to cancel without saving the calibration expiration.

ONE-POINT CALIBRATION BEHAVIOR

Press **CAL** when "1 Pnt" message is displayed on the secondary LCD. One of the two options ("Pnt" or "OFFS") will start blinking (see pH CALIBRATION, ONE-POINT CALIBRATION for details, page 12).



Press the **ARROW** keys to toggle between "Pnt" and "OFFS" options.

Press **CFM** to save the behavior for one-point calibration.

Press **CAL** to escape without saving.

pH RESOLUTION (HI 2223 only)

Press **CAL** when "rESo" message is displayed on the secondary LCD. The set resolution ("0.01" or "0.001") will start blinking.



Press the **ARROW** keys to toggle between 0.01 and 0.001 options.

Press **CFM** to save the modified value.

Press **CAL** to escape without saving.

CURRENT TIME

Press the **CAL** key when the current time is displayed. The hour will start blinking.



Press the **ARROW** keys to change the hour.

Press the **RANGE** key. The minutes will start blinking.

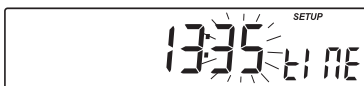

Press the **ARROW** keys to change the displayed value.

Press the **CFM** key to save the modified value or press the **CAL** key to escape without saving.

CURRENT DATE

Press the **CAL** key when the current date is displayed. The year will start blinking.



Press the **ARROW** keys to change the year.

Press the **RANGE** key. The month will start blinking.



Press the **ARROW** keys to change the month.

Press the **RANGE** key. The day will start blinking.



Press the **ARROW** keys to change the day.

Press the **CFM** key to save the modified value or press the **CAL** key to escape without saving.

BEEP STATUS

Press **CAL** when the beep status is displayed. Beep status ("On" or "OFF") will start blinking.



Press the **ARROW** keys to change the beep status (On or OFF).

Press **CFM** to save the modified beep status.

Press **CAL** to escape without saving.

When enable, beep sounds as a short beep every time a key is pressed or when the calibration can be confirmed.

A long beep alert that the pressed key is not active or a wrong condition is detected while in calibration.

INSTRUMENT ID

Press the **CAL** key when "InId" is displayed. The instrument ID ("0000" to "9999") will begin blinking.



Press the **ARROW** keys to change the instrument ID value.

Press the **CFM** key to save the modified instrument ID value or press the **CAL** key to cancel without saving the instrument ID.

Note: The instrument ID is downloaded to a PC as part of a logged data set to identify its origin.

TEMPERATURE UNIT

Press **CAL** when "tenP" is displayed. The temperature unit will start blinking.



Press the **ARROW** keys to change the option.

Press **CFM** to save the modified temperature unit.

Press **CAL** to escape without saving.

TEMPERATURE CALIBRATION (for technical personnel only)

All the instruments are factory calibrated for temperature.

Hanna's temperature probes are interchangeable and no temperature calibration is needed when they are replaced.

If the temperature measurements are inaccurate, temperature recalibration should be performed.

For an accurate recalibration, contact your dealer or the nearest Hanna Customer Service Center, or follow the instructions below.

- Prepare a vessel containing ice and water and another one containing hot water (around 50 °C). Place insulation material around the vessels to minimize temperature changes.
- Use a calibrated thermometer with a resolution of 0.1 °C as a reference thermometer.
- With the instrument off, press and hold down the **CFM & SETUP** keys, then power on the instrument. The "CAL" tag will appear and the secondary LCD will show "0.0 °C".

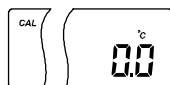

- Submerge the temperature probe in the vessel with ice and water as near as possible to the reference thermometer. Allow a few seconds for the probe to stabilize.
- Use the **ARROW** keys to set the reading on the secondary LCD to that of ice and water, measured by the reference thermometer. When the reading is stable and close to the selected calibration point, "READY" tag will appear and "CFM" tag will blink.

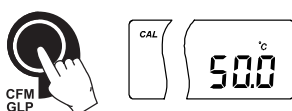

- Press **CFM** to confirm. The secondary LCD will show "50.0 °C".
- Submerge the temperature probe in the second vessel as near as possible to the reference thermometer. Allow a few seconds for the probe to stabilize.

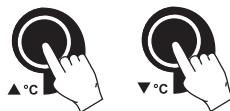

- Use the **ARROW** keys to set the reading on the secondary LCD to that of the hot water.

- When the reading is stable and close to the selected calibration point, “READY” tag will appear and “CFM” tag will blink.
- Press CFM to confirm. The instrument returns to measurement mode.



Note: If the reading is not close to the selected calibration point, “WRONG” tag will blink. Change the temperature probe and restart calibration.

mV CALIBRATION (for technical personnel only)

All the instruments are factory calibrated for mV.

Hanna's ORP electrodes are interchangeable and no mV calibration is needed when they are replaced.

If the mV measurements are inaccurate, mV recalibration should be performed.

For an accurate recalibration, contact your dealer or the nearest Hanna Customer Service Center, or follow the instructions below.

A two-point calibration can be performed at 0.0 mV and 1800.0 mV.

- Attach to the BNC connector a mV simulator with an accuracy of ± 0.1 mV.
- With the instrument off, press and hold down the **CAL & ▼ °C** keys, then power on the instrument. The "**CAL**" tag will appear and the secondary LCD will show "**0.0 mV**".
- Set 0.0 mV on the simulator.

When the reading is stable and close to the selected calibration point, "**READY**" tag will appear and "**CFM**" tag will blink.

- Press **CFM** to confirm. The secondary LCD will display "**1800 mV**".
- Set 1800.0 mV on the simulator.

When the reading is stable and close to the selected calibration point, "**READY**" tag will appear and "**CFM**" tag will blink.

- Press **CFM** to confirm. The instrument returns to measurement mode.

Note: If the reading is not close to the selected calibration point, "**WRONG**" tag will blink. Verify calibration condition or contact your vendor if you can not calibrate.

PC INTERFACE

Data transmission from the instrument to the PC can be done with the HI 92000 Windows® compatible software (optional). HI 92000 also offers graphing and on-line help feature.

Data can be exported to the most popular spreadsheet programs for further analysis.

To connect your instrument to a PC, use a standard USB cable connector. Make sure that your instrument is switched off and plug one connector to the instrument USB socket and the other to the USB port of your PC.

Note: If you are not using Hanna Instruments HI 92000 software, please see the following instructions.

SENDING COMMANDS FROM PC

It is also possible to remotely control the instrument with any terminal program. Use a standard USB cable to connect the instrument to a PC, start the terminal program and set the communication options as follows: 8, N, 1, no flow control, 9600 baud rate.

COMMAND TYPES

To send a command to the instrument follow the next scheme:

<command prefix> <command> <CR>

where: <command prefix> is a 16 ASCII character
<command> is the command code.

Note: Either small or capital letters can be used.

SIMPLE COMMANDS

RNG	Is equivalent to pressing RANGE
CAL	Is equivalent to pressing CAL
CFM	Is equivalent to pressing CFM
UPC	Is equivalent to pressing the UP arrow key
DWC	Is equivalent to pressing the DOWN arrow key
LOG	Is equivalent to pressing LOG
RCL	Is equivalent to pressing RCL
SET	Is equivalent to pressing SETUP
CHR xx	Change the instrument range according with the parameter value (xx): <ul style="list-style-type: none">• xx=00 pH value/0.001 resolution (HI 2223 only)• xx=01 pH range/0.01 resolution• xx=03 mV range

The instrument will answer for these commands with:

<STX> <answer> <ETX>

where: <STX> is 02 ASCII code character (start of text)

<ETX> is 03 ASCII code character (end of text)

<answer> :

<ACK> is 06 ASCII code character (recognized command)

<NAK> is 21 ASCII code character (unrecognized command)

<CAN > is 24 ASCII code character (corrupted command)

COMMANDS REQUIRING AN ANSWER

The instrument will answer for these commands with:

<STX> <answer> <checksum> <ETX>

where the checksum is the bytes sum of the answer string sent as 2 ASCII characters.

All the answer messages are with ASCII characters.

RAS Causes the instrument to send a complete set of readings in according with the current range:

- pH, temperature and mV reading on pH range.
- mV and temperature reading on mV range

The answer string contains:

- Meter mode (2 chars):
 - 00 - pH value (0.001 resolution)
 - 01 - pH range (0.01 resolution)
 - 03 - mV range
- Meter status (2 chars of status byte): represents a 8 bit hexadecimal encoding.
 - 0x10 - temperature probe is connected
 - 0x01 - new GLP data available
 - 0x02 - new SETUP parameter
- Reading status (2 chars): R - in range, O - over range, U - under range. First character corresponds to the pH range reading. (Not for HANNA ORP electrodes with pin.) Second character corresponds to mV reading.
- pH reading on pH range only - 7 ASCII chars, including sign and decimal point. (Not for HANNA ORP electrodes with pin.)
- mV reading - 7 ASCII chars, including sign and decimal point.

- Temperature reading - 8 ASCII chars, with sign and two decimal points, always in °C.
- MDR** Requests the instrument model name and firmware code (16 ASCII chars).
- GLP** Requests the calibration data record.
- The answer string contains:
- GLP status (1 char): represents a 4 bit hexadecimal encoding.
 - 0x01 - pH calibration available
 - pH calibration data (if available), which contains:
 - the number of calibrated buffers (1 char)
 - the offset, with sign and decimal point (7 chars)
 - the average of slopes, with sign and decimal point (7 chars)
 - the calibration time, **yymmddhhmmss** (12 chars)
 - buffers information (for each buffer)
 - type (1 char): 0 - standard (always 0)
 - status (1 char): N (new) - calibrated in last calibration; O (old) - from an old calibration.
 - warnings during calibration (2 chars):
 - 00 - no warnings
 - 01 - clean electrode
 - 04 - clean electrode and check buffer
 - 05 - contaminated buffer.
 - buffer value, with sign and decimal point (7 chars).
 - calibration time, **yymmddhhmmss** (12 chars).
 - electrode condition, with sign (3 chars). The "-01" code means not calculated.
 - electrode response with sign (3 chars). The "-01" code means not calculated.
- PAR** Requests the setup parameters setting.
- The answer string contains:
- Instrument ID (4 chars)
 - Calibration alarm time out (2 chars)
 - SETUP information (2 chars): 8 bit hexadecimal encoding.
 - 0x01 - beep ON (else OFF)
 - 0x04 - degrees Celsius (else degrees Fahrenheit)
 - 0x08 - Offset calibration (else Point calibration)

NSL Requests the number of logged samples (4 chars).

LODxxx Requests the xxxth record logged data.

LODALL Requests all Log on demand data.

The answer string contains:

- pH resolution (2 chars): 00 - pH 0.001 resolution, 01 - pH 0.01 resolution
- pH reading status (1 char): R - in range, O - over range, U - under range
- pH reading with sign and decimal point (7 chars)
- Temperature reading sign and decimal point in °C (7 chars)
- mV reading status (1 char - R, O, U)
- mV reading with sign and decimal point (7 chars)
- the logged time, **yymmddhhmmss** (12 chars)
- the calibration offset with sign and decimal point (7 chars)
- the average of slopes with sign and decimal point (7 chars)
- temperature probe presence (1 char)

Errors: • "Err3" is sent if the Log on demand is empty.

- "Err4" is sent if the requested set parameter is not available.
- "Err5" is sent if an argument of the command is not correct.
- "Err6" is sent if the requested range is not available.
- "Err7" is sent if the instrument is in logging mode.
- "Err8" is sent if the instrument is not in measurement mode.
- Invalid commands will be ignored.

ELECTRODE CONDITIONING & MAINTENANCE

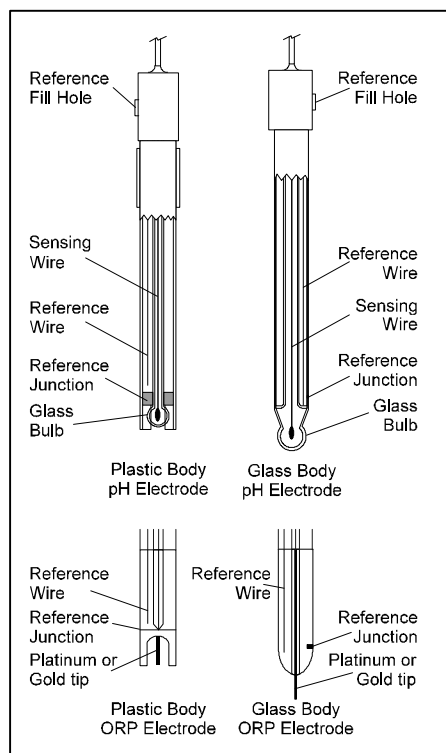

PREPARATION PROCEDURE

Remove the protective cap of the pH electrode.

DO NOT BE ALARMED IF SALT DEPOSITS ARE PRESENT. This is normal with electrodes. They will disappear when rinsed with water.

During transport, tiny bubbles of air may form inside the glass bulb affecting proper functioning of the electrode. These bubbles can be removed by "shaking down" the electrode as you would do with a glass thermometer.

If the bulb and/or junction is dry, soak the electrode in **HI 70300** or **HI 80300** Storage Solution for at least one hour.

For refillable electrodes:

If the filling solution (electrolyte) is more than 2½ cm (1") below the fill hole, add **HI 7082** or **HI 8082** 3.5M KCl Electrolyte Solution for double junction or **HI 7071** or **HI 8071** 3.5M KCl + AgCl Electrolyte Solution for single junction electrodes.

For faster response, unscrew the fill hole screw during measurements.

For AMPHEL® electrodes:

If the electrode does not respond to pH changes, the battery is run down and the electrode should be replaced.

MEASUREMENT

Rinse the electrode tip with distilled water. Submerge the tip (3 cm / 1¼") in the sample and stir gently for a few seconds.

For a faster response and to avoid cross-contamination of the samples, rinse the electrode tip with a few drops of the solution to be tested, before taking measurements.

STORAGE PROCEDURE

To minimize clogging and assure a quick response time, the glass bulb and the junction should be kept moist and not allowed to dry out.

Replace the solution in the protective cap with a few drops of **HI 70300** or **HI 80300** Storage Solution or, in its absence, Filling Solution (**HI 7071** or **HI 8071** for single junction and **HI 7082** or **HI 8082** for double junction electrodes). Follow the Preparation Procedure before taking measurements.

Note: NEVER STORE THE ELECTRODE IN DISTILLED OR DEIONIZED WATER.

PERIODIC MAINTENANCE

Inspect the electrode and the cable. The cable used for connection to the instrument must be intact and there must be no points of broken insulation on the cable or cracks on the electrode stem or bulb. Connectors must be perfectly clean and dry. If any scratches or cracks are present, replace the electrode. Rinse off any salt deposits with water.

For refillable electrodes:

Refill the reference chamber with fresh electrolyte (**HI 7071** or **HI 8071** for single junction and **HI 7082** or **HI 8082** for double junction electrodes).

Allow the electrode to stand upright for 1 hour.

Follow the Storage Procedure above.

CLEANING PROCEDURE

- General Soak in Hanna **HI 7061** or **HI 8061** General Cleaning Solution for approximately ½ hour.
- Protein Soak in Hanna **HI 7073** or **HI 8073** Protein Cleaning Solution for 15 minutes.
- Inorganic Soak in Hanna **HI 7074** Inorganic Cleaning Solution for 15 minutes.
- Oil/grease Rinse with Hanna **HI 7077** or **HI 8077** Oil and Fat Cleaning Solution.

IMPORTANT: After performing any of the cleaning procedures, rinse the electrode thoroughly with distilled water, refill the reference chamber with fresh electrolyte (not necessary for gel-filled electrodes) and soak the electrode in **HI 70300** or **HI 80300** Storage Solution for at least 1 hour before taking measurements.

TROUBLESHOOTING GUIDE

SYMPTOMS	PROBLEM	SOLUTION
Slow response/excessive drift.	Dirty pH electrode.	Clean the electrode and then soak the tip in HI 7061 or HI 8061 for 30 minutes.
Readings fluctuate up and down (noise).	Clogged/dirty junction. Low electrolyte level (refillable electrodes only).	Clean the electrode. Refill with fresh solution (for refillable electrodes only). Check cable and connectors.
The meter does not accept the buffer solution for calibration.	Dirty electrode or contaminated buffer.	Follow the cleaning procedure. If still no results, replace the electrode. Replace buffer.
If the display shows: "pH" and "-2.00" or "16.00" blinking.	Out of range in the pH scale.	a) Verify that the electrode is connected. b) Verify that the shipping cap has been removed. c) Recalibrate the meter. d) Make sure the pH sample is in the specified range. e) Check electrolyte level and general state of the electrode.
If the display shows: "mV" and "-2000" or "2000" blinking	Out of range in the mV scale.	Verify that the electrode is connected.
The meter does not work with the temperature probe.	Broken temperature probe. Wrong temperature probe used.	Replace the temperature probe.
The meter fails to calibrate or gives faulty readings.	Broken pH electrode.	Replace the electrode.
At startup the meter displays all LCD tags permanently.	One of the keys is stuck.	Check the keyboard or contact the vendor.
"Err xx" error message displayed.	Internal error.	Power off the meter and then power it on. If the error persists, contact the vendor.

TEMPERATURE CORRELATION FOR pH SENSITIVE GLASS

The resistance of glass electrodes partially depends on the temperature. The lower the temperature, the higher the resistance. It takes more time for the reading to stabilize if the resistance is higher. In addition, the response time will suffer to a greater degree at temperatures below 25 °C.

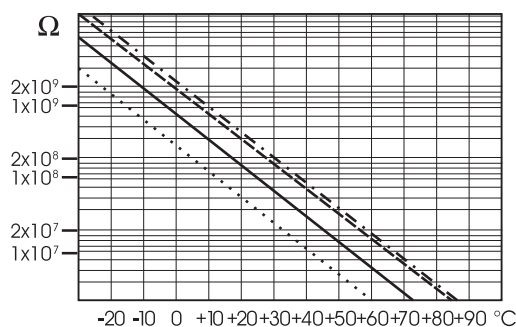

Since the resistance of the pH electrode is in the range of 50 – 200 Mohm, the current across the membrane is in the pico Ampere range. Large currents can disturb the calibration of the electrode for many hours.

For these reasons high humidity environments, short circuits and static discharges are detrimental to a stable pH reading.

The pH electrode's life also depends on the temperature. If constantly used at high temperatures, the electrode life is drastically reduced.

Typical Electrode Life

Ambient Temperature	1 – 3 years
90 °C	Less than 4 months
120 °C	Less than 1 month

Alkaline Error

High concentrations of sodium ions interfere with readings in alkaline solutions. The pH at which the interference starts to be significant depends upon the composition of the glass. This interference is called alkaline error and causes the pH to be underestimated. Hanna's glass formulations have the indicated characteristics.

Sodium Ion Correction for the Glass at 20-25 °C		
Concentration	pH	Error
0.1 Mol L ⁻¹ Na ⁺	13.00	0.10
	13.50	0.14
	14.00	0.20
1.0 Mol L ⁻¹ Na ⁺	12.50	0.10
	13.00	0.18
	14.00	0.40

ACCESSORIES

pH BUFFER SOLUTIONS

- HI 70004P pH 4.01 Buffer Sachets, 20 mL, 25 pcs
- HI 70007P pH 7.01 Buffer Sachets, 20 mL, 25 pcs
- HI 70010P pH 10.01 Buffer Sachets, 20 mL, 25 pcs
- HI 7001L pH 1.68 Buffer Solution, 500 mL
- HI 7004L pH 4.01 Buffer Solution, 500 mL
- HI 7006L pH 6.86 Buffer Solution, 500 mL
- HI 7007L pH 7.01 Buffer Solution, 500 mL
- HI 7009L pH 9.18 Buffer Solution, 500 mL
- HI 7010L pH 10.01 Buffer Solution, 500 mL
- HI 8004L pH 4.01 Buffer Solution in FDA approved bottle, 500 mL
- HI 8006L pH 6.86 Buffer Solution in FDA approved bottle, 500 mL
- HI 8007L pH 7.01 Buffer Solution in FDA approved bottle, 500 mL
- HI 8009L pH 9.18 Buffer Solution in FDA approved bottle, 500 mL
- HI 8010L pH 10.01 Buffer Solution in FDA approved bottle, 500 mL

ELECTRODE STORAGE SOLUTIONS

- HI 70300L Storage Solution, 500 mL
- HI 80300L Storage Solution in FDA approved bottle, 500 mL

ELECTRODE CLEANING SOLUTIONS

- HI 70000P Electrode Rinse Sachets, 20 mL, 25 pcs
- HI 7061L General Cleaning Solution, 500 mL
- HI 7073L Protein Cleaning Solution, 500 mL
- HI 7074L Inorganic Cleaning Solution, 500 mL
- HI 7077L Oil & Fat Cleaning Solution, 500 mL
- HI 8061L General Cleaning Solution in FDA approved bottle, 500 mL
- HI 8073L Protein Cleaning Solution in FDA approved bottle, 500 mL
- HI 8077L Oil & Fat Cleaning Solution in FDA approved bottle, 500 mL

ELECTRODE REFILL ELECTROLYTE SOLUTIONS

- HI 7071 3.5M KCl + AgCl Electrolyte, 4x30 mL, for single junction electrodes
- HI 7072 1M KNO₃ Electrolyte, 4x30 mL
- HI 7082 3.5M KCl Electrolyte, 4x30 mL, for double junction electrodes
- HI 8071 3.5M KCl + AgCl Electrolyte in FDA approved bottle, 4x30 mL, for single junction electrodes
- HI 8072 1M KNO₃ Electrolyte in FDA approved bottle, 4x30 mL
- HI 8082 3.5M KCl Electrolyte in FDA approved bottle, 4x30 mL, for double junction electrodes.

ORP PRETREATMENT SOLUTIONS

- HI 7091L Reducing Pretreatment Solution, 500 mL
- HI 7092L Oxidizing Pretreatment Solution, 500 mL

pH ELECTRODES

All electrodes with part numbers ending in P are supplied with a BNC and pin connector and 1 m (3.3') cable, as shown below.

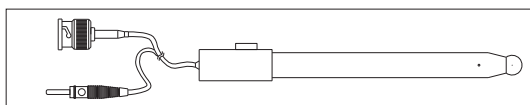

HI 1043P; Use: strong acid/alkali.
Glass-body, double junction, refillable, combination pH electrode.

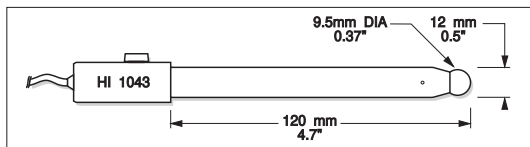

HI 1053P; Use: emulsions.
Glass-body, triple ceramic, conic shape, refillable, combination pH electrode.

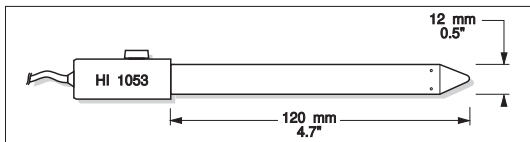

HI 1131P; Use: general purpose.
Glass-body, single junction, refillable, combination pH electrode.

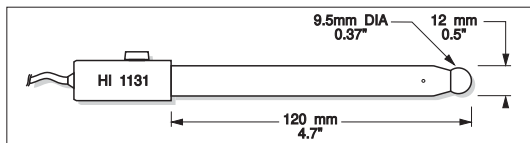

HI 1083P; Use: biotechnology, micro titration.
Glass-body, micro, Viscolene, nonrefillable, combination pH electrode.

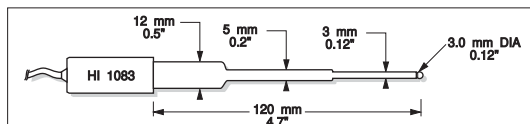

ORP ELECTRODES

HI 3131P; Use: titration.

Glass-body, refillable, combination platinum ORP electrode.

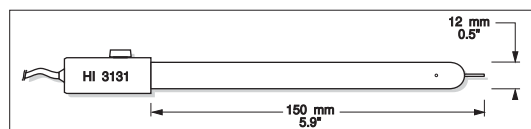

Consult the Hanna General Catalog for more electrodes with BNC and pin connectors.

EXTENSION CABLE FOR SCREW-TYPE ELECTRODES (SCREW TO BNC ADAPTER)

HI 7855/1 Extension cable 1 m (3.3') long

HI 7855/3 Extension cable 3 m (9.9') long

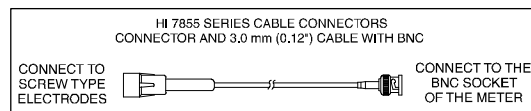

OTHER ACCESSORIES

- HI 710005 Voltage adapter from 115 VAC to 12 VDC (USA plug)
- HI 710006 Voltage adapter from 230 VAC to 12 VDC (European plug)
- HI 710012 Voltage adapter from 240 VAC to 12 VDC (UK plug)
- HI 710013 Voltage adapter from 230 VAC to 12 VDC (South Africa plug)
- HI 710014 Voltage adapter from 230 VAC to 12 VDC (Australia plug)
- HI 76404N Electrode holder

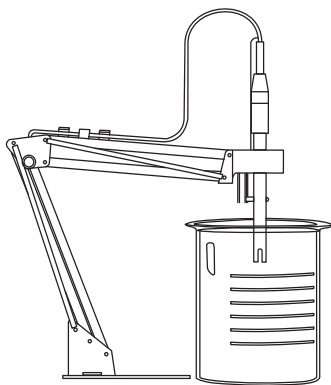

- HI 8427 pH and ORP electrode simulator with 1 m (3.3') coaxial cable ending in female BNC connectors
- HI 931001 pH and ORP electrode simulator with LCD and 1 m (3.3') coaxial cable ending in female BNC connectors
- HI 7662 Temperature probe with 1 m (3.3') cable
- HI 92000 Windows® compatible software.

Windows® is registered Trademark of "Microsoft Co."

RECOMMENDATIONS FOR USERS

Before using these products, make sure they are entirely suitable for the environment in which they are used.

Operation of these instruments in residential areas could cause unacceptable interferences to radio and TV equipment, requiring the operator to follow all necessary steps to correct interferences.

The glass bulb at the end of the pH electrode is sensitive to electrostatic discharges. Avoid touching this glass bulb at all times.

During operation, ESD wrist straps should be worn to avoid possible damage to the electrode by electrostatic discharges.

Any variation introduced by the user to the supplied equipment may degrade the instruments' EMC performance.

To avoid electrical shock, do not use these instruments when voltages at the measurement surface exceed 24 VAC or 60 VDC.

To avoid damage or burns, do not perform any measurement in microwave ovens.

Hanna Instruments reserves the right to modify the design, construction and appearance of its products without advance notice.



Hanna Instruments Inc.
Highland Industrial Park
584 Park East Drive
Woonsocket RI 028985 USA

Local Sales and Customer Service office

Hanna Instruments United States Inc.
Highland Industrial Park
584 Park East Drive
Woonsocket RI 028985 USA
Tel. (800) 426 6287
Fax (401) 765 7575
www.hannainst.com/usa

Technical Support for customers
Telephone (800) 426 6287
Fax (401) 765 7575
E-mail tech@hannainst.com