

Dual Laser Video IR Video Thermometer

MODEL VIR50

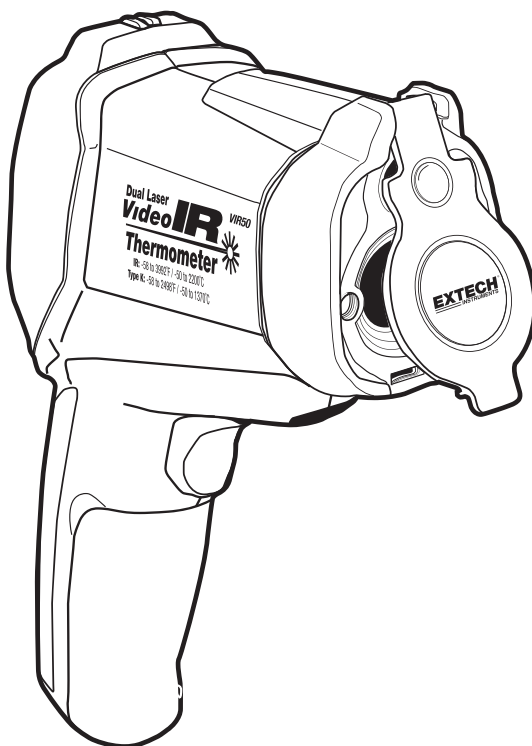

Introduction

Congratulations on your purchase of the Video IR Thermometer. This meter is capable of making non-contact (infrared) and contact (thermocouple) temperature measurements. The built-in camera offers still image and video capturing functionality for documenting measurement locations. The meter includes a micro SD card slot for offloading still images and video.

The built-in laser pointer increases target accuracy while the backlit LCD and handy push-buttons combine for convenient, ergonomic operation. This meter is shipped fully tested and calibrated and, with proper use, will provide years of reliable service.

Features

- 2.2" TFT LCD display
- 640 x 480 pixels Digital Camera
- Micro SD memory card
- Image (JPEG) and video (3gp)
- Humidity and Air Temperature Measurements
- Dual laser targeting
- Type-K thermocouple probe for contact measurements
- Adjustable emissivity
- High accuracy
- Fast response time
- Dew-point temperature and Wet bulb temperature functions

Safety

- Use extreme caution when the laser pointer beam is on
- Do not point the beam toward anyone's eye or allow the beam to strike the eye from a reflective surface
- Do not use the laser near explosive gases or in other potentially explosive areas



Meter Description

1. LCD Display
2. Push-buttons (UP/Picture, ESC, and DOWN/VIDEO)
3. Measurement Trigger
4. Retractable Lens Cover
5. Camera, Lasers, and IR sensor
6. Compartment for Type-K jack, USB jack, Reset button
7. Handle Grip and cover for Micro SD memory card slot and Rechargeable Battery

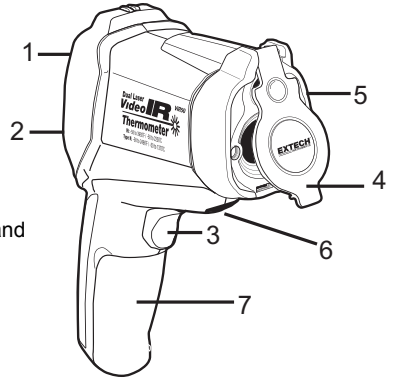

Rear Panel

- 1 Display
- 2 ▲ and Camera button
- 3 Power and ESC button
- 4 ENTER button
- 5 ▼ and Video button

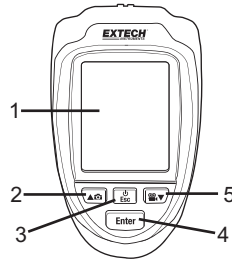

Front View

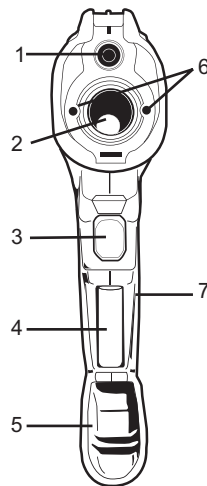

- 1 Camera lens
- 2 IR thermometer lens
- 3 Measurement trigger
- 4 Battery
- 5 Battery cover
- 6 Laser pointers
- 7 Micro SD card port



Note: A tripod mount is located on the bottom of the handle

Operation

Power ON and OFF

1. The instrument is powered by one (1) rechargeable battery (3.7V). The battery is housed in the compartment in the meter's handle.
2. The supplied battery charger connects to the USB port on the instrument (in the compartment above the measurement trigger).
3. Once the battery is charged, Press and Hold the  button for 5 seconds to switch the instrument ON.
4. Press and Hold the  button to switch the unit OFF.
5. In the event that the instrument freezes operation (no reaction when pressing any button), insert a paper clip into the Reset opening to trigger the RESET function.
6. For accurate readings, wait 30 seconds after powering on to allow the meter to stabilize.

Measurement Modes

The meter has four (4) measurement modes: Video + Infrared, Infrared-only, Dew Point, and Datalogging mode. When the meter is switched ON, the first screen that appears is the mode selection screen. Use the ▲/▼ buttons to highlight the desired mode and then press the ENTER button to access the mode.

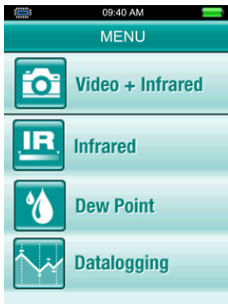











Video + Infrared mode: the meter functions as an IR meter with the camera capabilities;

Infrared-only mode: the meter functions as an IR meter only;

Dew Point mode: the meter shows the Dew Point temperature value;

Datalogging mode: the meter functions as a measurement storage/retrieval device.

Display Symbols



Symbol	Description	Symbol	Description
	Video + IR mode		High alarm
	IR-only mode		High alarm triggering
	Dew Point mode		Low alarm
	Laser		Low alarm triggering
	Scan		Hold

Video + IR mode

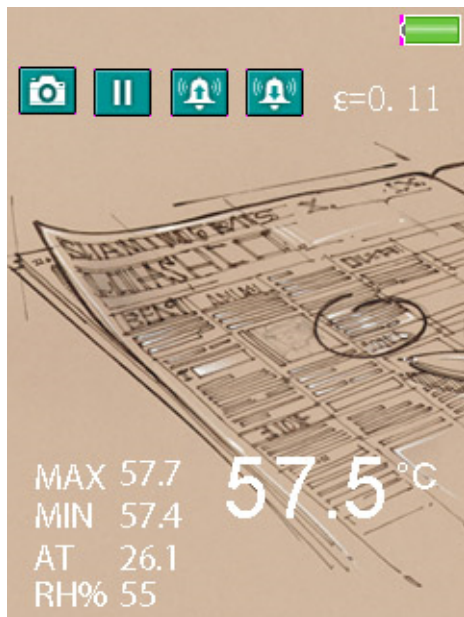

In the Video + IR Mode the meter can measure IR temperature, air temperature, humidity, dew-point temperature, and wet bulb temperature, along with full use of the video camera capabilities. The IR Maximum (MAX) Temperature, IR Minimum (MIN) Temperature, IR Differential (DIF) Temperature, and the IR Average (AVG) Temperature can also be displayed. Press and hold trigger to measure the temperature.



Capturing Still Images (Photographs)

In the Video + IR mode, press the  button to take a photograph. Press the  button again to save the photo (the SAVE soft-key will appear above the up arrow button after the photograph is taken). Press the  button to cancel the photo

Capturing Video

In the Video + IR mode, press the  button to enter the video capture mode and then press the  button again to begin recording video. Press the ESC button to exit. Use the  button to stop the video.

IR-only mode

In the IR-only Mode the meter can measure IR temperature, air temperature, air humidity, dew-point temperature, and wet bulb temperature but without the video camera capabilities. The IR Maximum (MAX) Temperature, IR Minimum (MIN) Temperature, IR Differential (DIF) Temperature, and the IR Average (AVG) Temperature can also be displayed. Press and hold trigger to measure the temperature.

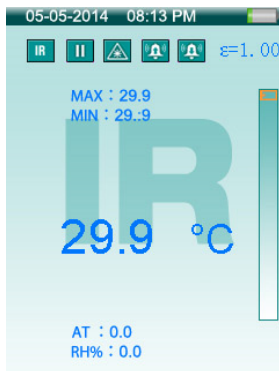

Dew Point Temperature Mode

In the Dew Point mode the meter displays the Dew Point temperature measurement along with the IR temperature value. Press and hold the measurement trigger to take a measurement.

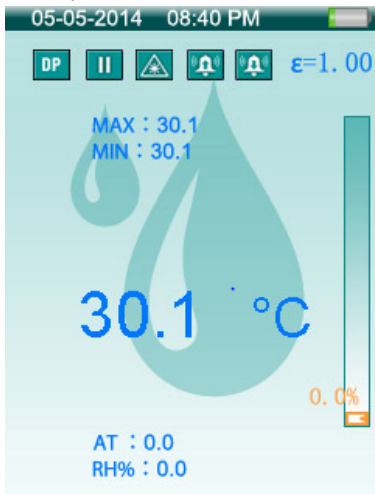

In the Dew Point mode the percentage bargraph indicates how close the IR temperature is to the Dew Point temperature. At 100%, the two values are identical.

Datalogging Mode

The datalogger automatically records readings to memory at a programmed interval. In the Datalogging mode, the high/low alarm values, low alarm value, datalogging interval sampling rate (time), can be configured.

Once configured, press the trigger to start logging. The unit will automatically record data at the specified sampling time. Press the ESC button to exit the DATALOG mode, the meter will automatically save the data to a file.

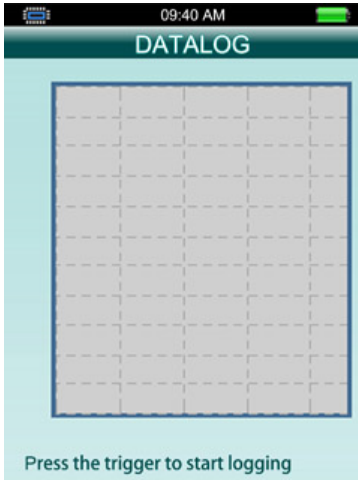

Set the high and low alarm values for the datalogger

From the Datalogger screen (shown above) use the arrow keys to select the HIGH or the LOW alarm value parameter and then press the ENTER button. Use the ▲ and ▼ buttons to adjust the alarm value, then press the ENTER button to confirm.

Set interval time for the datalogger

From the Datalogger screen use the arrow keys to select the interval TIME parameter and then press the ENTER button. Use the ▲ and ▼ buttons to adjust the time value (logger sampling rate) in seconds and then press the ENTER button to confirm.

Select the line color for the datalogger

From the Datalogger screen use the arrow keys to select the COLOR parameter and then press the ENTER button. Use the ▲ and ▼ buttons to select a line color and then press the ENTER button to confirm.

System Tools Settings

From the Video + IR, IR-only, or Dew Point modes, press the ENTER button to access the soft-key screen. The System Tools is the icon on the left. Use the arrow buttons to scroll over to the System Tools icon if it is not already highlighted.



Press the ENTER button again when the System Tools icon is highlighted to access the System Tools settings mode. From the datalogger mode scroll down to the Measure Set parameter and press ENTER to access to the System Tools setting menu.

Use the ▲ and ▼ buttons to select an item and then press the ENTER button to access it.

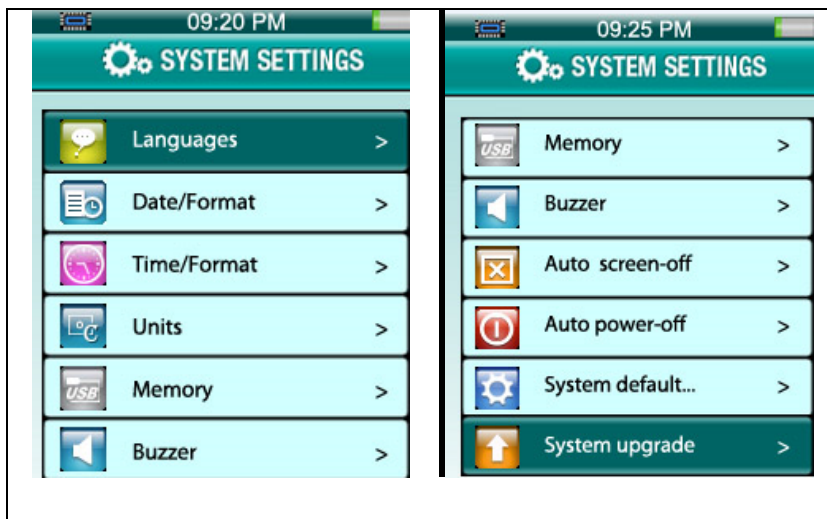

Item	Description
Languages	Set the language
Date/Format	Set the date and format of the date
Time/Format	Set the time and format of the time
Units	Select the temperature unit of measure
Memory	Display the memory and SD card capacity
Buzzer	Set the buzzer on or off
Auto screen-off	Select the time before the screen automatically turns off
Auto power-off	Select the time before the VIR50 automatically powers off.
System Default Setting	Restores the VIR50 to its default settings
System Upgrade	Upgrades the system via the SD card

Setting the Language

Use the ▲ and ▼ buttons to select the desired language, and press the ENTER button to confirm.



Setting the Date

Use the ▲ and ▼ buttons to select the desired format for the date, and press the ENTER button to confirm. Once the format has been chosen, use the ▲ and ▼ buttons to select the day, month, and year.

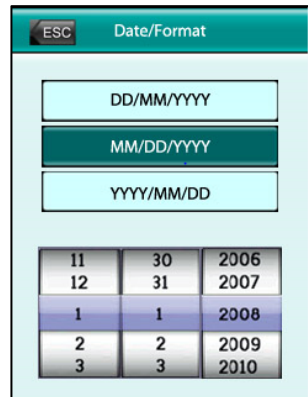

Setting the Time

Use the ▲ and ▼ buttons to select the desired format for the time, and press the ENTER button to confirm. Once the format has been chosen, use the ▲ and ▼ buttons to select the minute, hour, and AM/PM (where applicable).

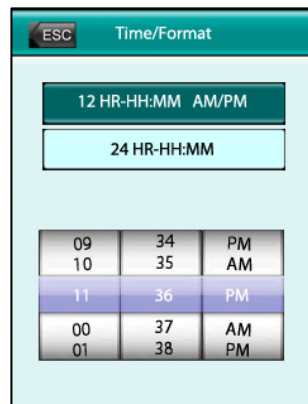

Setting the temperature units (C/F)

Use the ▲ and ▼ buttons to select the desired unit of measure, press the ESC button to exit and save.

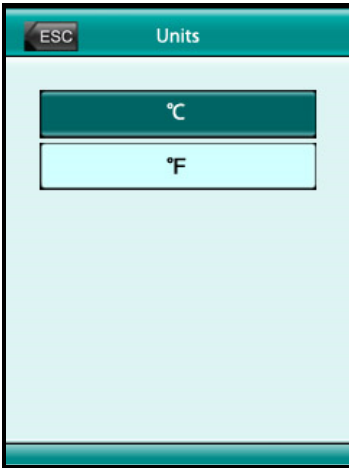

Memory

Use the ▲ and ▼ buttons to select either FLASH or SD CARD, and press the ENTER button to confirm. Then select either WORKING SPACE or FORMAT, and press the ENTER button to confirm.

If FORMAT was pressed, click YES or NO to confirm.

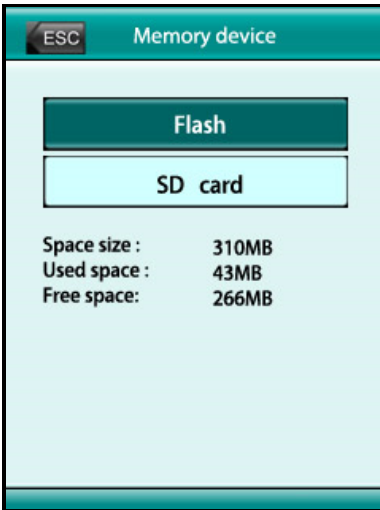

Setting the Buzzer ON or OFF

Use the ▲ and ▼ buttons to select either ON or OFF, and press the ENTER button to confirm.

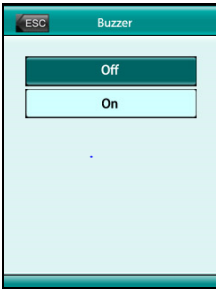

Setting the Auto Power off time

Use the ▲ and ▼ buttons to disable or select an auto-power-off time, press the ESC button to exit and save.

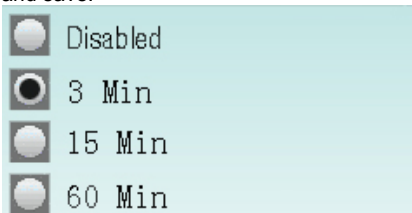

Setting the Screen Timeout

Use the ▲ and ▼ buttons to disable or select a screen auto-off time, press the ESC button to exit and save.

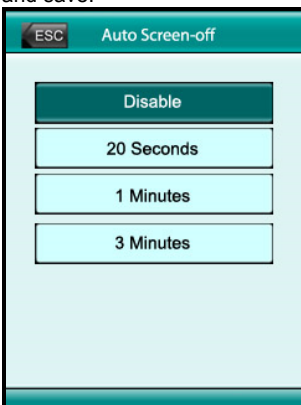

Selecting the Memory Type

If there is no SD card present in the VIR50, then only a single blue icon will be displayed on the LCD screen in the top left corner.

If there is an SD card present, but the memory is being used by the device, then there will be two icons, a chip (blue i.e. enabled), and a blank SD card icon to the right of it

If there is an SD card present, and the memory is being used by the SD card, then there will be two icons, a chip (blank), and a blue SD card icon with the letters "SD" on it., meaning that the SD card is being used to store memory.

System Default Setting

Use the ▲ and ▼ buttons to select either YES (revert to the factory default settings) or NO (cancel).

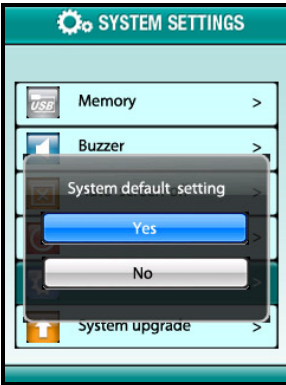

System Upgrade

Make sure there is an SD card present in the VIR50. Press the ENTER button, and make sure there is a steady current powering the VIR50. Press the ENTER button again to confirm the upgrade, and press the ENTER button one more time to begin the upgrade through the SD card.

When the update is complete, press the ENTER button to return to the home screen.

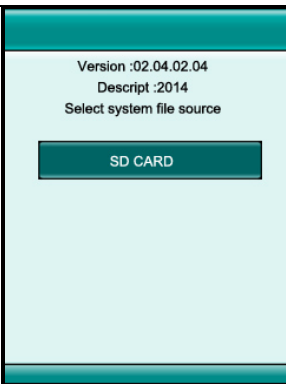

Measurement Settings

From the Video + IR, IR-only, or Dew Point modes, press the ENTER button to access the soft-key screen. The Measurement Settings mode is represented by the middle icon. Use the arrow buttons to scroll over to the middle icon (if it is not already highlighted.)



Press the ENTER button again when the middle icon is highlighted to access the Measurement Settings mode as shown below.

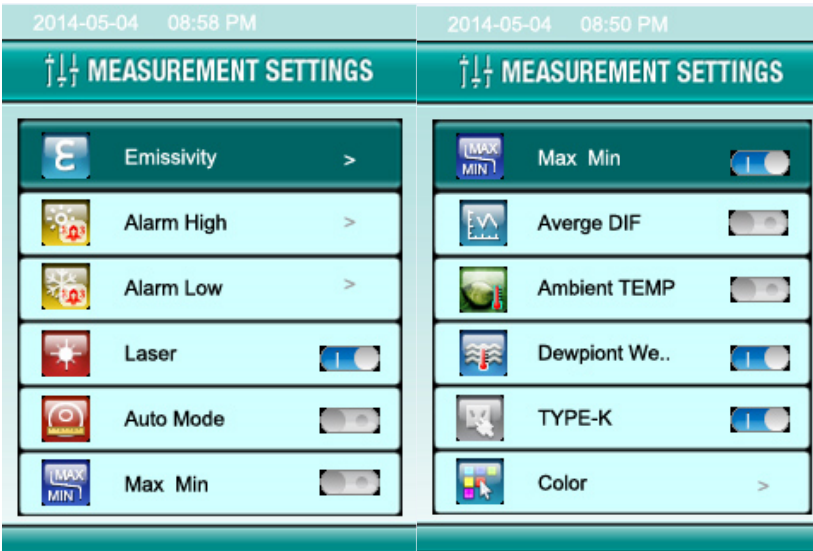

Item	Description
Emissivity set	Set the emissivity
Alarm High	Set the high alarm ON/OFF and set the alarm limit
Alarm Low	Set the low alarm ON/OFF and set the alarm limit
Laser	Enable or disable the laser pointer
Auto Mode	Lock the measurement ON
Max Min	Display the highest (MAX) or lowest (MIN) IR temperature
Average DIF	Display Average temperature or Differential IR temperature
Ambient TEMP	Display the air temperature and relative humidity
Dewpoint Wet Bulb	Display the dew-point and wet bulb temperature
Type K	Enable or disable the type-k contact thermocouple input
Color	Set the color

Emissivity setting

Use the arrow buttons to highlight an emissivity setting and then press ENTER to choose it. Select emissivity by description (concrete, glass, etc.) or select $\epsilon=0.94$ to set the emissivity manually using the arrow buttons. Press the ESC button to exit and save.

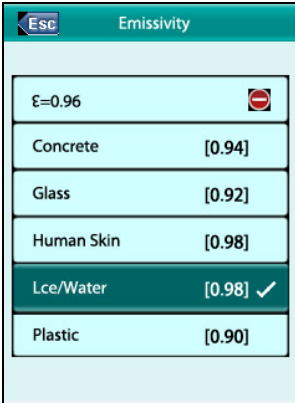

Alarm High

Use the ▲ and ▼ buttons enable or disable the alarm. If the high alarm is enabled, press the ENTER button to adjust its value; use the ▲ and ▼ buttons to adjust the value. Press the ENTER button to conform and then press the ESC button to exit and save.

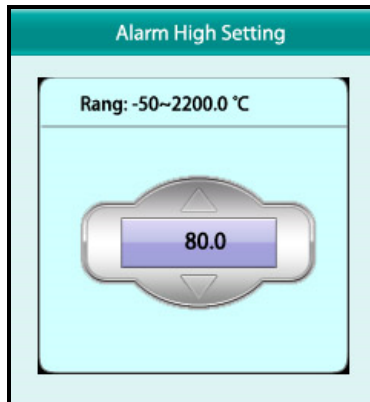

Alarm Low

Use the ▲ and ▼ buttons enable or disable the alarm. If the low alarm is enabled, press the ENTER button to adjust its value; use the ▲ and ▼ buttons to adjust the value. Press the ENTER button to confirm and then press the ESC button to exit and save.

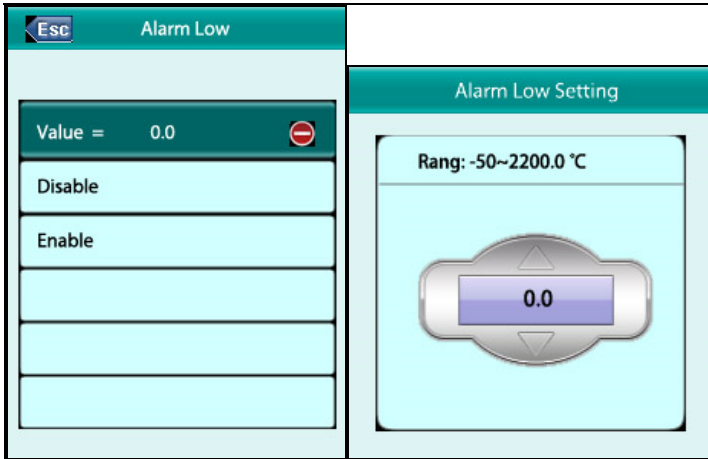

Laser

Press the ENTER button to enable or disable the laser.

Auto Mode (Measure Lock)

Press the ENTER button to enable or disable auto mode.

Max/Min

Press the ENTER button to set the MAX/MIN mode ON or OFF. The MAX/MIN mode displays the highest (MAX) and lowest (MIN) IR temperature.

Average/Dif

Press the ENTER button to switch ON or OFF the Average or Differential IR temperature.

Ambient TEMP/% RH

Press the ENTER button to switch the air temperature and relative humidity displays ON or OFF.

Dew-point/wet bulb temperature

Press the ENTER button to switch the dew-point and wet bulb temperature ON or OFF.

Type k

Press the ENTER button to enable or disable the Type k contact thermocouple input.

NOTE: If a Type-k probe is inserted into the meter's thermocouple jack (in the compartment over the measurement trigger), 'Enable' will be selected by default. Select the Disable setting to prohibit the LCD from displaying Type-k temperature.

Color

Use the ▲ and ▼ buttons choose a color. Press the ESC button to exit and save.

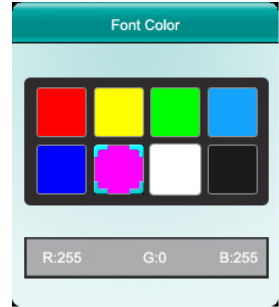

Memory Setting Mode

From the Video + IR, IR-only, or Dew Point modes, press the ENTER button to access the soft-key screen. The Memory Settings mode is represented by the icon on the right. Use the arrow buttons to scroll over to the right icon (if it is not already highlighted). Press the ENTER button again when the right icon is highlighted to access the Memory Settings mode.



Use the ▲ and ▼ buttons to select Picture, Video or Logs and then press the ENTER button to access the selection.

Use the ENTER button to view a Picture, Video or Data log. Press the ENTER button to delete a picture, video or log. Use the ▲ button to confirm a deletion and press the ▼ button to cancel a deletion.

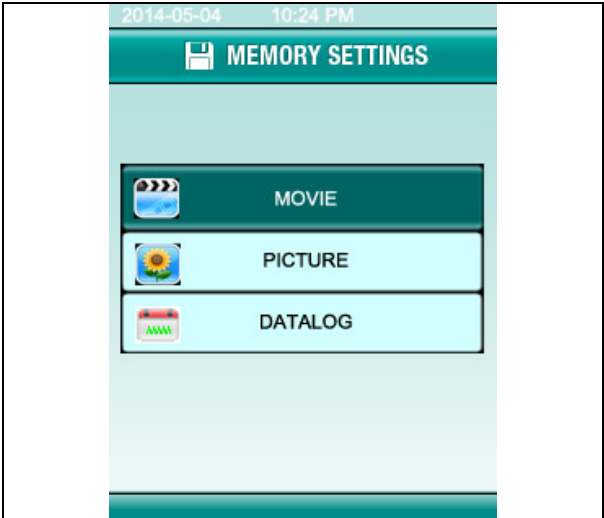

Item	Description
Picture	Display saved images
Video	Playback saved videos
Logs	Display datalogger data

Transfer files to a PC

Connect the USB cable from the thermometer to a USB port on the pc or insert the microSD card into the SD port on the pc.. If the USB cable is used, the USB symbol will appear in the display and the PC will recognize the unit as a removable drive.

Open the drive to view the three folders:

LOGS: Text files, use the *.txt files

PICTURE: Pictures, use the *.jpg files

VIDEO: Videos, use the *.3gp files

Note: other file types are used by the thermometer for internal requirements

Note: If the *.3gp video files will not play on any installed media software, a software plug-in is available on the supplied CD which will allow compatibility with Media Player.

Battery Charging and Replacement

When the battery display symbol appears empty or close to empty, recharge the Lithium ion 3.7V/1400mAh rechargeable battery. Connect the supplied USB battery cable to the mini USB jack in the compartment above the measurement trigger and then connect the other end of the cable to an AC source. Charge time is approx. 2 hours.

The battery is located in the compartment behind the handle panel and beneath the meter's trigger. The panel can be released and folded down as shown in the diagram. Replace the battery if necessary with one of the **same type and specifications** and close the battery compartment cover.

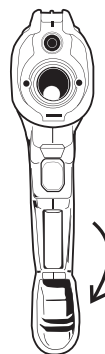

You, as the end user, are legally bound (**Battery ordinance**) to return all used batteries and accumulators; **disposal in the household garbage is prohibited!**

You can hand over your used batteries / accumulators at collection points in your community or wherever batteries / accumulators are sold!

Disposal: Follow the valid legal stipulations in respect of the disposal of the device at the end of its lifecycle

IR Measurement Notes

1. The object under test should be larger than the spot (target) size calculated by the field of view diagram (printed on the side of the meter and in this guide).
2. Before measuring, be sure to clean surfaces that are covered with frost, oil, grime, etc.
3. If an object's surface is highly reflective, apply masking tape or flat black paint to the surface before measuring. Allow time for the paint or tape to adjust to the temperature of the surface it is covering.
4. Measurements through transparent surfaces such as glass may not be accurate.
5. Steam, dust, smoke, etc. can obscure measurements.
6. The meter automatically compensates for deviations in ambient temperature. However, it can take up to 30 minutes for the meter to adjust to extremely wide changes.
7. To find a hot spot, aim the meter outside the area of interest then scan across (in an up and down motion) until the hot spot is located.

Field of View

The meter's lasers converge at a distance of 50 inches (127cm) which is the optimum measurement distance for this meter. At this distance the measurement spot has a 1 inch (2.54cm) diameter. The Distance to Spot Ratio determines the measured spot size for the distance used. For this meter the ratio is 50:1 or: 1"(2.54cm) spot @ 50" (1.27m), 2"(5.08cm) spot @ 100"(2.54m) or 0.5"(1.27cm) spot @ 25"(0.64m).

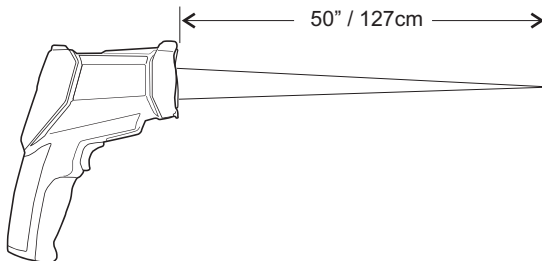

Emissivity and IR Measurement Theory

IR Thermometers measure the surface temperature of an object. The thermometer's optics sense emitted, reflected, and transmitted energy. The thermometer's electronics translate the information into a temperature reading which is then displayed on the LCD.

The amount of IR energy emitted by an object is proportional to an object's temperature and its ability to emit energy. This ability is known as emissivity and is based upon the material of the object and its surface finish. Emissivity values range from 0.1 for a very reflective object to 1.00 for a flat black finish. For the VIR50, the emissivity is adjustable from 0.1 to 1.00 (see the Measurement Settings section earlier in this User Guide). Most organic materials and painted or oxidized surfaces have an emissivity factor of 0.94. When in doubt, set the emissivity to 0.94.

Emissivity Factors for Common Materials

Material under test	Emissivity	Material under test	Emissivity
Asphalt	0.90 to 0.98	Cloth (black)	0.98
Concrete	0.94	Skin (human)	0.98
Cement	0.96	Leather	0.75 to 0.80
Sand	0.90	Charcoal (powder)	0.96
Soil	0.92 to 0.96	Lacquer	0.80 to 0.95
Water	0.92 to 0.96	Lacquer (matt)	0.97
Ice	0.96 to 0.98	Rubber (black)	0.94
Snow	0.83	Plastic	0.85 to 0.95
Glass	0.90 to 0.95	Timber	0.90
Ceramic	0.90 to 0.94	Paper	0.70 to 0.94
Marble	0.94	Chromium Oxides	0.81
Plaster	0.80 to 0.90	Copper Oxides	0.78
Mortar	0.89 to 0.91	Iron Oxides	0.78 to 0.82
Brick	0.93 to 0.96	Textiles	0.90

Specifications

Infrared Thermometer Specifications

Range	-58 to 3992°F (-50 to 2200°C)	
Resolution	0.1°C/F < 1000; 1°C/F > 1000	
Accuracy	-50°C to -20°C (-58°F to -4°F)	Not specified
	-19.9°C to -1°C (-3.9°F to 30°F)	± (2% rdg + 6°F/3.3°C)
	-0.9°C to 100°C (30.1°F to 212°F)	± (1.0% rdg + 4°F/2.2°C):
	100.1°C to 454°C (212.1°F to 850°F)	± (2.5% rdg + 4°F/2.2°C)
	454.1°C to 1000°C (850.1°F to 1832°F)	± (2.5% rdg + 6°F/3.3°C)
	1001°C to 2200°C (1833°F to 3992°F)	± (3% rdg + 9°F/5°C)
	Note: Accuracy is specified for the following ambient temperature range: 64 to 82°F (18 to 28°C) and at 127cm (50")	
Repeatability	-58°F to 68°F (-50°C to 20°C)	± 2.7°F (1.5°C)
	68°F to 1832°F (20°C to 1000°C)	± 0.5% or ±0.9°F (0.5°C)
	1832°F to 3992°F (1000°C to 2200°C)	± 1.0%
Emissivity	Adjustable from 0.1 to 1.00	
Field of View	D/S = Approx. 50:1 ratio (D = distance, S = spot)	
Laser power	Less than 1mW (Class II)	
Spectral response	8 to 14 μm (wavelength)	
Response time	150ms	

Type K Thermometer Specifications

Range / Resolution	-58 to 2498°F (-50 to 1370°C)	0.1°C/F < 1000; 1°C/F > 1000
Accuracy	32°F to 2498°F (0°C to 1370°C)	± (0.5% + 2.7°F/1.5°C):
	-58°F to 32°F (-50°C to 0°C)	± 4.5F (2.5C)
	Note: Accuracy is specified for the following ambient temperature range: 64 to 82°F (18 to 28°C)	

Air Temperature and Relative Humidity Specifications

Air Temperature Range / Resolution	32 to 122°F (0 to 50°C)	0.1°C/F
Dew Point Range / Resolution	32 to 122°F (0 to 50°C)	0.1°C/F
Relative Humidity Range / Resolution	0 to 100%	1%
Air Temperature Accuracy	50°F to 104°F (10°C to 40°C)	± 1.8°F (1°C)
	All other ranges	± 3.6°F (2°C)
Dew Point Temperature Accuracy	Based on temperature and RH specifications	
Relative Humidity Accuracy	40 to 60%	± 5.0%RH:
	20% to 40% and 60% to 80%	± 5.0%RH
	0% to 20% and 80% to 100%	± 6.0%RH

General Specifications

Display	2.2" Color TFT LCD (320 x 240 pixels)
Digital Camera	640 x 480 pixels
Operating Temperature	32°F to 122°F (0°C to 50°C)
Memory	Internal flash: 49Mbyte, Micro SD card: Max 8Gbytes
Operating Humidity	Max. 90% RH (non-condensing)
Power Supply	3.7V Lithium ion rechargeable battery
Battery life	4 hours (continuous) approx.
Battery charge time	2 hours with AC adaptor or USB connection
Automatic Power Off	Programmable: OFF, 3, 15, and 60 minutes
Weight	0.9 lbs. / 410g
Dimensions	8.1 x 2.4 x 6.1" (205 x 62 x 155mm)

Copyright © 2014 FLIR Systems, Inc.

All rights reserved including the right of reproduction in whole or in part in any form

www.extech.com