

User's Guide

EXTECH[®]
INSTRUMENTS

A FLIR COMPANY

200Amp AC Clamp Meter + NCV

Model MA250

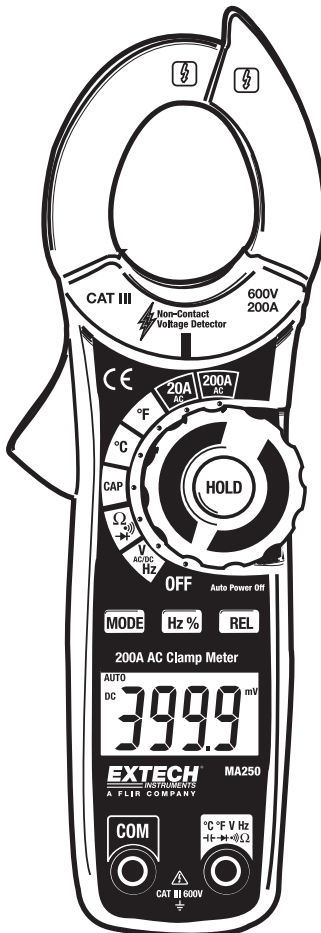

Introduction

Congratulations on your purchase of this Extech MA250 Clamp Meter. This meter measures AC Current, AC/DC Voltage, Resistance, Capacitance, Frequency, Diode Test, Duty Cycle and Continuity. Special features include Thermocouple Temperature and Non-Contact Voltage detection. The double molded case is designed for heavy duty use. This meter is shipped fully tested and calibrated and, with proper use, will provide years of reliable service.

Safety

International Safety Symbols



This symbol, adjacent to another symbol or terminal, indicates the user must refer to the manual for further information.



This symbol, adjacent to a terminal, indicates that, under normal use, hazardous voltages may be present



Double insulation



This **WARNING** symbol indicates a potentially hazardous situation, which if not avoided, could result in death or serious injury.



This **CAUTION** symbol indicates a potentially hazardous situation, which if not avoided, may result damage to the product.

PER IEC1010 OVERVOLTAGE INSTALLATION CATEGORY

OVERVOLTAGE CATEGORY I

Equipment of OVERVOLTAGE CATEGORY I is equipment for connection to circuits in which measures are taken to limit the transient overvoltages to an appropriate low level.

Note – Examples include protected electronic circuits.

OVERVOLTAGE CATEGORY II

Equipment of OVERVOLTAGE CATEGORY II is energy-consuming equipment to be supplied from the fixed installation.

Note – Examples include household, office, and laboratory appliances.

OVERVOLTAGE CATEGORY III

Equipment of OVERVOLTAGE CATEGORY III is equipment in fixed installations.

Note – Examples include switches in the fixed installation and some equipment for industrial use with permanent connection to the fixed installation.

OVERVOLTAGE CATEGORY IV

Equipment of OVERVOLTAGE CATEGORY IV is for use at the origin of the installation.

Note – Examples include electricity meters and primary over-current protection equipment

SAFETY NOTES

- Do not exceed the maximum allowable input range of any function.
- Do not apply voltage to meter when resistance function is selected.
- Set the function switch OFF when the meter is not in use.
- Remove the battery if meter is to be stored for longer than 60 days.

WARNINGS

- Set function switch to the appropriate position before measuring.
- When measuring volts do not switch to current/resistance modes.
- Do not measure current on a circuit whose voltage exceeds 600V.
- When changing ranges always disconnect the test leads from the circuit under test.

CAUTIONS

- Improper use of this meter can cause damage, shock, injury or death. Read and understand this user manual before operating the meter.
- Always remove the test leads before replacing the battery or fuses.
- Inspect the condition of the test leads and the meter itself for any damage before operating the meter. Repair or replace any damage before use.
- Use great care when making measurements if the voltages are greater than 25VAC rms or 35VDC. These voltages are considered a shock hazard.
- Always discharge capacitors and remove power from the device under test before performing Diode, Resistance or Continuity tests.
- Voltage checks on electrical outlets can be difficult and misleading because of the uncertainty of connection to the recessed electrical contacts. Other means should be used to ensure that the terminals are not "live".
- If the equipment is used in a manner not specified by the manufacturer, the protection provided by the equipment may be impaired.

Function	Maximum Input
A AC,	200A
V DC, V AC	600V DC/AC
Resistance, Capacitance, Frequency, Diode Test, Continuity, Temperature	250V DC/AC

Description

Meter Description

1. Current clamp
2. NCV LED indicator
3. Clamp opening trigger
4. MODE button
5. HZ/% button
6. LCD Display
7. Negative input jack
8. Non-Contact Voltage Detector
9. HOLD button
10. Function Switch
11. Relative Button
12. Battery compartment (rear)
13. Positive input jack

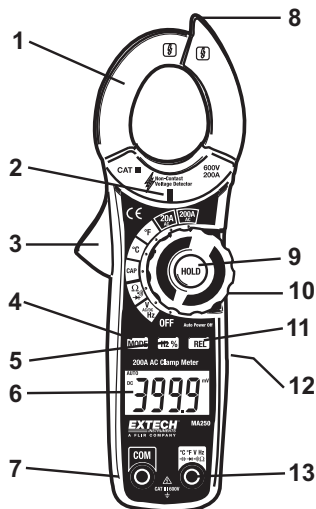

Display icons Description

HOLD	Data Hold
AUTO	Autoranging
DC	Direct Current
AC	Alternating Current
	Low battery
REL	Relative
V	Volts (Voltage)
Ω	Ohms (Resistance)
A	Amperes (Current)
F	Farad (Capacitance)
Hz	Hertz (Frequency)
%	Duty Ratio
°F and °C	Fahrenheit and Celsius units (Temperature)
n, m, μ, M, k	Unit of measure prefixes: nano, milli, micro, mega, and kilo
•))	Continuity test
	Diode test

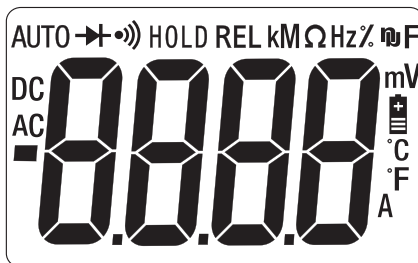

Operation

NOTES: Read and understand all **Warning** and **Caution** statements in this operation manual prior to using this meter. Set the function select switch to the OFF position when the meter is not in use.

Non-Contact Voltage Detector

WARNING: Risk of Electrocution. Before use, always test the Voltage Detector on a known live circuit to verify proper operation.

1. Rotate the Function switch to any measurement position.
2. Place the detector probe tip on the conductor to be tested.
3. If AC voltage is present, the NCV detector light will turn on with a steady red light.

NOTE: The conductors in electrical cord sets are often twisted. For best results, move the probe tip along a length of the cord to assure placing the tip in close proximity to the live conductor.

NOTE: The detector is designed with high sensitivity. Static electricity or other sources of energy may randomly trip the sensor. This is normal operation.

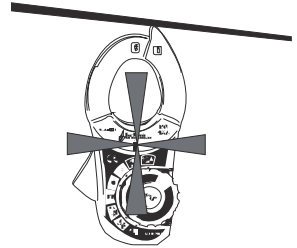

AC Current Measurements

WARNING: Disconnect the test leads before making clamp measurements.

1. Rotate the Function switch to the **200A** position
2. Press the trigger to open jaw. Fully enclose only one conductor.
3. Read the current value in the display.
4. If the value is less than 40A, rotate the function switch to the **20A** position to improve resolution.

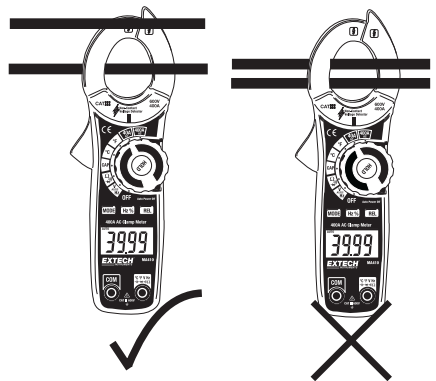

AC/DC Voltage, Frequency, Duty Cycle Measurements

CAUTION: Do not measure voltages if a motor on the circuit is being switched ON or OFF. Large voltage surges may occur that can damage the meter.

1. Rotate the function switch to the **V** position.
2. Press the **MODE** button to select AC or DC Voltage.
3. Insert the black test lead banana plug into the negative **COM** jack. Insert the red test lead banana plug into the positive **V** jack.
4. Touch the black test probe tip to the negative side of the circuit. Touch the red test probe tip to the positive side of the circuit.
5. Read the voltage value in the display.
6. Press the **Hz %** button to display Frequency
7. Press the **Hz %** button to display Duty Cycle

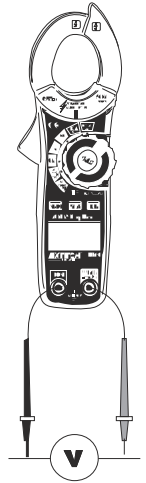

Resistance, Diode, Continuity Measurements

Note: Remove power from the device under test before making resistance measurements

1. Set the function switch to the Ω position.
2. Insert the black test lead banana plug into the negative **COM** jack. Insert the red test lead banana plug into the positive **V** jack.
3. Touch the black test probe tip to one side of the device. Touch the red test probe tip to the other side of the device.
4. Read the resistance value in the display.
5. Press the **MODE** button to select the **DIODE** mode. The Diode symbol will appear in the display.
6. Press the **MODE** button to select the **Continuity** mode. The continuity symbol will appear in the display. If the resistance is <150 ohms the tone will sound.



Capacitance Measurements

WARNING: To avoid electric shock, discharge the capacitor before measuring.

1. Rotate the function switch to the **CAP** capacitance position.
2. Insert the black test lead banana plug into the negative **COM** jack. Insert the red test lead banana plug into the positive \pm jack.
3. Touch the black test probe tip to one side of the device. Touch the red test probe tip to the other side of the device.
4. Read the capacitance value in the display.



Type K Temperature Measurements

1. Rotate the function switch to the **°F or °C** temperature position.
2. Insert the Temperature Probe into the input jacks.
3. Place the temperature probe tip(s) where needed.
4. Read the temperature on the display.

Note: In case of an open input or a temperature overrange, the meter will display "OL".

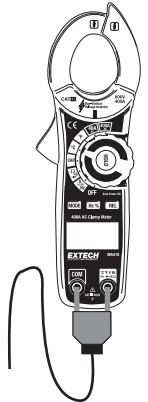

Data Hold

To freeze the LCD reading, press the **HOLD** button. The **HOLD** icon appears on the LCD. Press the **HOLD** button again to return to normal operation.

Relative

Press the **REL** button (**REL** will appear in the display) to zero the reading and create a reference point. All future reading will be the difference between the actual reading and the stored "REL" reading. In the REL mode, autoranging is disabled and measurements are limited to the range active when the **REL** button was pressed. Press the REL button to exit the mode.

Note: Relative does not function in Frequency or Duty Cycle mode.

Automatic Power Off

In order to conserve battery life, the meter will automatically turn off after approximately 30 minutes. To turn the meter on again, change the position of the function switch.

Low battery indication

When the  icon appears in the display, the battery should be replaced. Refer to the battery replacement procedure in the maintenance section.

Maintenance

WARNING: To avoid electrical shock, disconnect the meter from any circuit, remove the test leads from the input terminals, and turn OFF the meter before opening the case. Do not operate the meter with an open case.

Cleaning and Storage

Periodically wipe the case with a damp cloth and mild detergent; do not use abrasives or solvents. If the meter is not to be used for 60 days or more, remove the battery and store it separately.

Battery Replacement

1. Remove the 2 Phillips head screws that secures the rear battery cover
2. Open the battery compartment
3. Replace the 2 AAA batteries.
4. Secure the battery compartment door



You, as the end user, are legally bound (**EU Battery ordinance**) to return all used batteries, **disposal in the household garbage is prohibited!** You can hand over your used batteries / accumulators at collection points in your community or wherever batteries accumulators are sold!

Disposal: Follow the valid legal stipulations in respect of the disposal of the device at the end of its lifecycle

Specifications

Function	Range	Resolution	Accuracy (% of reading + digits)
AC Current 50/60Hz	20.00 AAC	0.01A	±(2.5% + 8 digits)
	200.0 AAC	0.1A	±(2.8% + 8 digits)
AC Voltage 50 to 400Hz	4.000 VAC	0.001V	±(1.8% + 8 digits)
	40.00 VAC	0.01V	
	400.0 VAC	0.1V	
	600 VAC	1V	±(2.5% + 8 digits)
DC Voltage	400.0 mVDC	0.1mV	±(0.8% + 2 digits)
	4.000 VDC	0.001V	±(1.5% + 2 digits)
	40.00 VDC	0.01V	
	400.0 VDC	0.1V	
	600 VDC	1V	±(2.0% + 2 digits)
Resistance	400.0Ω	0.1Ω	±(1.0% + 4 digits)
	4.000kΩ	0.001kΩ	±(1.5% + 2 digits)
	40.00kΩ	0.01kΩ	
	400.0kΩ	0.1kΩ	
	4.000MΩ	0.001MΩ	±(2.5% + 3 digits)
	40.00MΩ	0.01MΩ	±(3.5% + 5 digits)
Capacitance	40.00nF	0.01nF	±(4.0% + 20 digits)
	400.0nF	0.1nF	±(3.0% + 5 digits)
	40.00μF	0.01μF	
	100.0μF	0.1μF	
Frequency	10 to 10kHz	0.01Hz	±(1.5% + 2 digits)
	Sensitivity: 15V rms		
Duty Cycle	0.5% to 99.0%	0.1%	±(1.2% + 2 digits)
	Pulse width: 100μs to 100ms, Frequency: 10Hz to 10kHz		
Temperature Type K	-4.0 to 1400°F	0.1° <400°	±(3% + 9°F/5°C)
	-20 to 760°C	1° >400°	
Specification does not include probe accuracy. Range of supplied probe is -22 to 572°F (-30 to 300°C).			

General Specifications

Clamp jaw opening	30mm (1.18") approx.
Display	4,000 count LCD
Continuity check	Threshold <150Ω; Test current < 0.5mA
Diode test	Test current of 0.3mA typical; Open circuit voltage [1.5VDC typical
Low Battery indication	Battery symbol is displayed
Over-range indication	'OL' display
Measurement rate	2 readings per second, nominal
Thermocouple sensor	Type K thermocouple required
Input Impedance	10MΩ (VDC and VAC)
AC bandwidth	50 to 400Hz (VAC)
AC response	Average responding
Operating Temperature	5°C to 40°C (41°F to 104°F)
Storage Temperature	-20°C to 60°C (-4°F to 140°F)
Operating Humidity	Max 80% up to 31°C (87°F) decreasing linearly to 50% at 40°C (104°F)
Storage Humidity	<80%
Operating Altitude	2000meters (7000ft) maximum.
Battery	Two "AAA" 1.5V batteries
Auto power OFF	After approx. 30 minutes
Dimensions & Weight	200x66x37mm (7.9x2.6x1.5"); 205g (7.23oz)
Safety	For indoor use and in accordance with the requirements for double insulation to IEC1010-1 (2001); EN61010-1 (2001) Overvoltage Category III 600V, Pollution Degree 2.
Approvals	CE, 

Copyright © 2011 Extech Instruments Corporation (a FLIR company)

All rights reserved including the right of reproduction in whole or in part in any form.

www.extech.com