

Portable Carbon Monoxide (CO) Meter

Model CO40

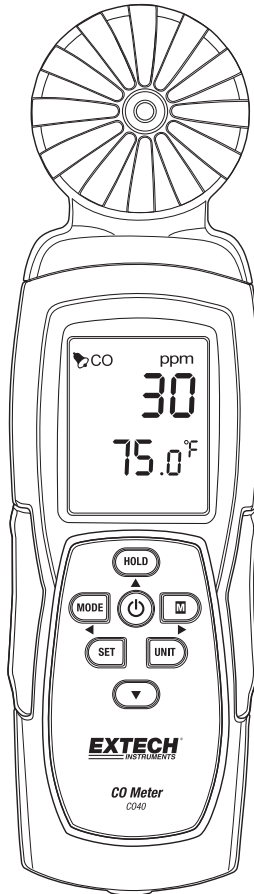

Introduction

Thank you for selecting the Extech Instruments Model CO40. The CO40 simultaneously measures CO concentration and Air Temperature. The CO40 is designed using vented ball technology for fast response (<30 seconds) for sensing CO gas.

The user-programmable high alarm alerts the user if the CO level rises above the programmed limit.

This device is shipped fully tested and calibrated and, with proper use, will provide years of reliable service. Please visit our website (www.extech.com) to check for the latest version of this User Guide, Product Updates, and Customer Support.

Features

- Portable meter capable of measuring CO and temperature accurately
- Measures CO (0~999ppm) with alarm (alarm default 30ppm)
- Dual display indicates air temperature and CO
- Adjustable CO alarm threshold (0 to 999ppm) with audible beeper
- Electrochemical, vented ball CO sensor technology
- Tripod mount
- Battery or AC Adaptor powered

IMPORTANT SAFETY NOTES

This Carbon Monoxide Monitor is intended for general purpose Air Quality monitoring only, and has not been certified for use pursuant to any state or city safety Carbon Monoxide Alarm or Monitoring requirements.

The CO40 Carbon Monoxide Monitor has not been tested by an independent lab to comply with UL 2034 or IAS 6-96 standard.

It is the responsibility of the customer to obtain and apply current local, state, and national regulations with regard to CO alarms, monitoring and testing.

Meter Description

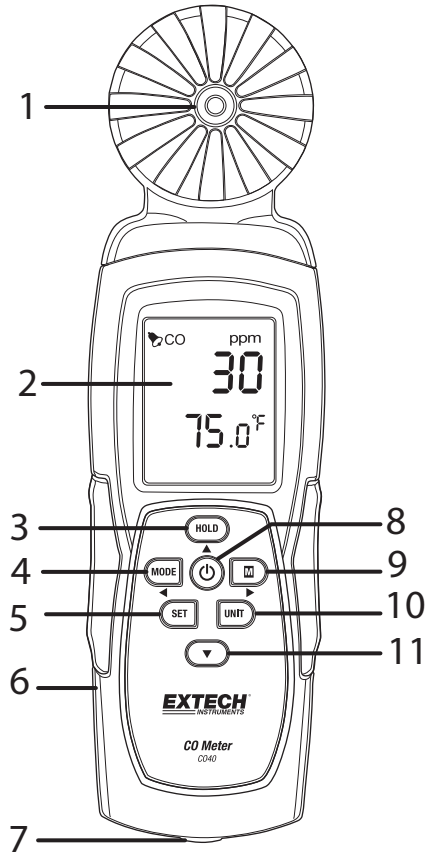

1. Sensors
2. LCD Display area
3. HOLD Button / ▲ Up arrow button
4. MODE / ◀ Left Arrow Button
5. SET Button
6. AC adaptor jack
7. Tripod Mount
8. POWER (⏻) Button
9. **M** (Max Reading) / ▶ Right Arrow Button
10. UNIT Button
11. ▼ Down Arrow Button

Note: Battery compartment on rear



Operation

Powering the meter

Momentarily press the  button to power on the meter. Hold the  button for 2 seconds to turn off the meter. During measurement, if the alarm is sounding (audible beeper) press the  button momentarily to turn off the beeper. Press again to activate the beeper. The alarm beeper is set to ON by default. The meter can be powered by 4 AAA batteries or AC adaptor.

Auto Power Off

The CO40 will automatically turn off after 15 minutes of inactivity. To disable the auto power off function: With the meter OFF, press and hold the **HOLD** button and then press the Power  button. The LCD will show “n”, and will then return to normal measurement mode.

Measurements

When the meter is turned on a self-test is performed as the LCD counts from “9999” down to “0000” and then enters the normal mode of operation where measurements are taken by the sensors and displayed on the LCD. The upper LCD area shows the CO reading in ppm and the lower LCD area shows the air temperature reading in °C/°F units of measure.

Selecting °C/°F units of measure

Press the **UNIT** button to select the desired temperature unit of measure.

Maximum Reading Memory

Momentarily press the **M** button to view the maximum readings captured since the meter was powered on (the MAX icon will be appear). Press **M** button again to return to normal operation.

Data Hold

Momentarily press the **HOLD** button to freeze the displayed readings (the HOLD icon will appear). Press the **HOLD** button again to return to normal operation.

Calibration

Press and hold the **MODE** button for 2 seconds to enter the self-calibration mode. Ensure that there is no CO present while calibrating. The LCD will display “CAL” and “oooo” flashing. Wait for approximately fifteen seconds, until the calibration is completed. “End” appears on the screen when calibration has completed. After five seconds, the meter then returns to its normal measurement mode.

CO High Alarm

Setting the Alarm Threshold

- Press and hold the **SET** button for 2 seconds to enter the high CO alarm threshold mode. The setting range is 0 to 999ppm (default is 30ppm)
- Press the **▲HOLD** button to increase the value and press the **▼** button to decrease the value
- Press the **MODE** button to select the digit to the left
- Press the **M** button to select the digit to the right
- Once the desired value is set, press the **SET** button for 2 seconds to save the alarm setting and to return to the normal mode

Arming/Disarming the Alarm

Momentary presses of the Power button  will arm/disarm the alarm (Bell icon appears when the alarm is armed)

Alarm beeper

When the alarm is triggered, the audible beeper will sound. A momentary press of the Power button will silence the alarm.

Battery Replacement

When the battery icon appears on the LCD, the batteries must be replaced.

In a downward motion, slide the rear battery compartment cover off of the meter housing.

Remove the old batteries and replace with new batteries (all of the same type) observing correct polarity. This meter uses four (4) 1.5V AAA batteries. Please replace the battery compartment cover before attempting to use the meter.

Battery Safety Reminders

- Please dispose of batteries responsibly; observe all relevant regulations.
- Never dispose of batteries in a fire; batteries may explode or leak.
- Never mix battery types; install new batteries of the same type.



Never dispose of used batteries or rechargeable batteries in household waste.

As consumers, users are legally required to take used batteries to appropriate collection sites, the retail store where the batteries were purchased, or wherever batteries are sold.

Disposal: Do not dispose of this instrument in household waste. The user is obligated to take end-of-life devices to a designated collection point for the disposal of electrical and electronic equipment.

Specifications

Display	Dual Multifunction LCD displays CO concentration, Air Temperature
CO Sensor	Vented ball, electrochemical CO measurement device
CO measurement range	0 to 999ppm
CO Response time	< 30 seconds
CO accuracy	±5% of reading or ± 10ppm
CO Resolution	1ppm
Temperature sensor	Thermistor
Temperature range	-10 to 50°C (14 to 122°F)
Temperature accuracy	0.6°C (±1.2°F)
Temperature resolution	0.1°C (0.1°F)
High CO Alarm	Audible alert when CO level rises above programmed limit (user-programmable from 0 to 999ppm; default is 30ppm)
Memory	Maximum reading (MAX) Hold and Data Hold
Power	Four (4) AAA batteries (with low battery indication) or AC Adaptor
Operating Temperature and Relative Humidity	0 to 50°C (32 to 122°F); 10~90%RH
Storage Temperature and Relative Humidity	-40 to 70°C (-40 to 158 °F); 0 ~ 95% RH
Dimensions	211 x 60 x 40mm (8.3 x 2.4 x 1.6")
Weight	181.4g (6.4 oz.)

Copyright © 2014 FLIR Systems, Inc.

All rights reserved including the right of reproduction in whole or in part in any form

www.extech.com