

Model 382275 and 382276

Single Output Laboratory Grade

Switching DC Power Supply

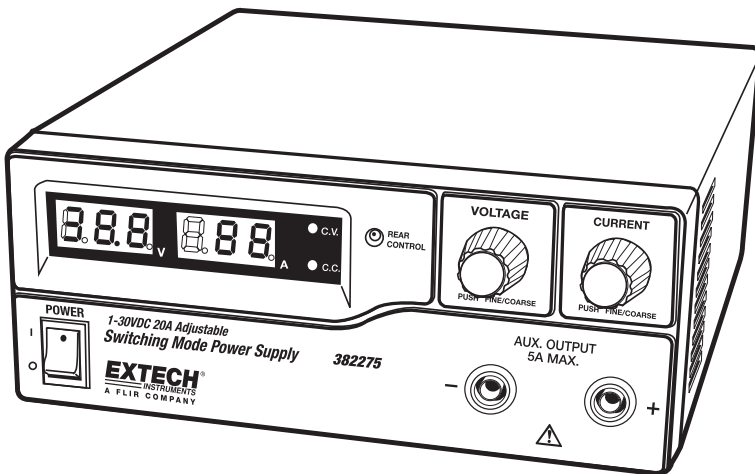

Introduction

Congratulations on your purchase of the Extech 382275 (110V) or 382276 (220V) Single Output Laboratory Grade DC Power Supply.

The dual action (coarse/fine tune) rotary encoder allows for quick and precise voltage and current level adjustments. Setting, changing, and checking the current limit level can be performed easily without sparking the output poles.

The remote control feature allows the user to remotely perform the following tasks:

- Output power ON/OFF
- Voltage and Current Level Adjustments

The three user-presets facilitate quick access to frequently used voltage and current settings. This power supply is shipped fully tested and calibrated and, with proper use, will provide years of reliable service.

Safety

WARNING

- **Do not use this power supply with electric motors or for charging purposes on electroplating equipment or similar devices. Return EMF and voltage transients generated by electric motors can damage this power supply. This power supply was designed for use on electronic equipment only and not intended for use on electrical equipment of any kind.**
- Do not use this power supply near water.
- Do not operate or touch this power supply with wet hands.
- Do not open the casing of the power supply when it is connected to AC power.
- Refer all servicing to qualified service personnel only.
- Before replacing the fuse, identify and fix any problems.
- Replace the fuse with a fuse of the specified type and rating.

CAUTION

- Use a grounded 3 pin AC source.
- This unit is intended for indoor use only.
- Do not operate or place this unit in direct sunlight or in a humid location
- Avoid environments where dust or dirt can enter the power supply casing.
- Do not place the power supply near a heat source.
- Before plugging into local AC mains, check the rating label at the back of the unit for 110V or 220V operation. The model 382275 can be powered by 110V only. The model 382276 can be powered by 220V only.
- Do not block the ventilation openings of the unit.
- This unit must be used within the specified rating; excessive continuous loading may cause damage to the power supply.
- The gauge size of the input power cable must be at least 3 “(0.75mm) and the total length of power cable must not exceed 118” (3m)

Power Supply Description

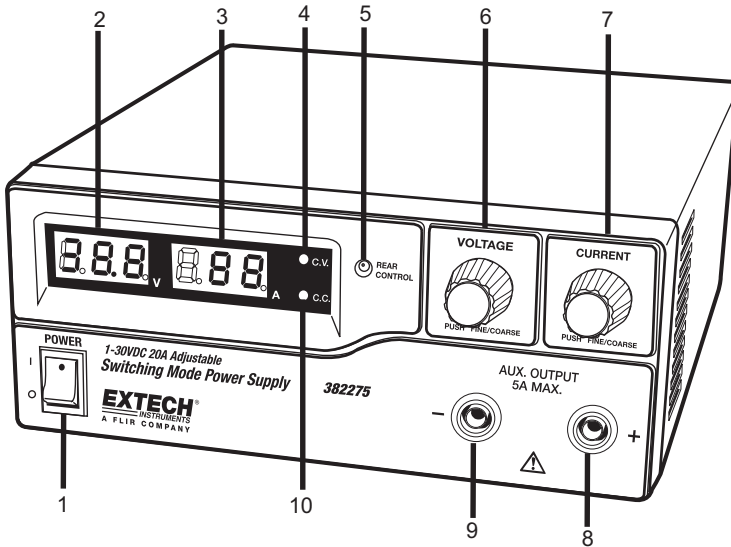

1. Power Switch ON/OFF
2. Voltage Display
3. Current Display
4. Constant Voltage Indicator LED
5. Rear Control Indicator LED (Switches ON when in Preset, Remote Control or Set Mode)
6. Output Voltage Control Knob (Controls both the main and auxiliary output voltage)
7. Output Current Control Knob (Controls both the main and auxiliary output current)
8. Positive Auxiliary Output Terminal (Max. 5 Amps)
9. Negative Auxiliary Output Terminal (Max. 5 Amps)
10. Constant Current Indicator LED

Rear Panel Description

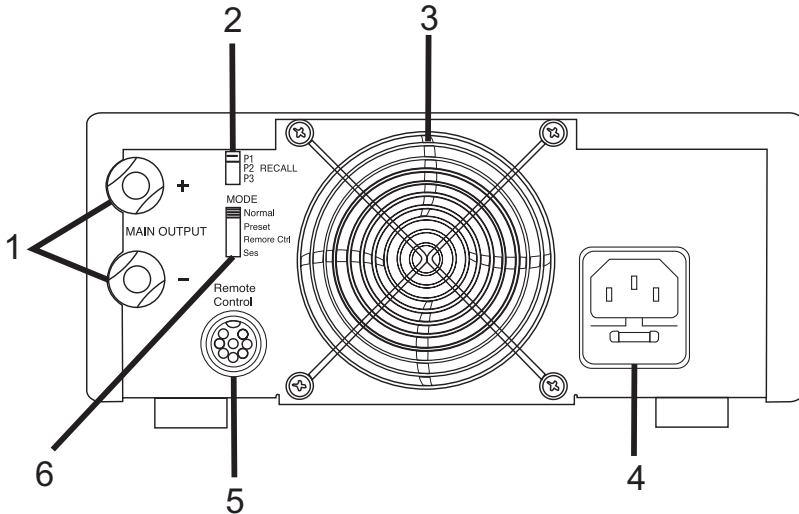

1. Main Output (20 Amps Max.)
2. P1, P2 and P3 Recall Switch
3. Cooling Fan for Ventilation
4. AC input Plug and Fuse
5. Remote Control Connector
6. Mode Switch

Mode Descriptions

Mode Selection

The power supply has four (4) modes of operation: NORMAL, PRESET, SET and REMOTE CONTROL mode. Slide the Mode Selection Switch to the desired Mode. The power supply defaults to the NORMAL Mode.

Normal Mode

Normal Mode is the factory preset mode. The power supply's output voltage and current are controlled by the dual action preset volume knobs. Push the knobs to toggle the coarse and fine tuning; notice the subtle changes in brightness of the related LED. Adjust the knob to the desired value first with the Coarse adjustment and then with the Fine tune adjustment. Turn the Current knob gently in any direction to check the preset current level. The display will resume its normal brightness after a few seconds to confirm the adjustment.

Preset Mode

In the PRESET mode, the Rear Control Light is switched ON to indicate that the panel voltage and current controls are de-activated.

There are three preset outputs, P1, P2 and P3, selectable via the Recall Switch, located on the rear of the power supply.

The preset values are factory set per the following table.

Presets	Output Voltage	Output Current
P1	5V	Maximum
P2	13.8V	Maximum
P3	25V	Maximum

Set Mode

In the SET mode, the Voltage and the Current values for the three presets (P1, P2, and P3) can be programmed.

1. Set the Mode Switch located on the rear of the power supply to the “SET” position.
2. Select a preset using the Recall Switch (set to the P1, P2 or P3 position).
3. Use the front panel Voltage Control Knob to set the desired voltage value.
4. Use the front panel Current Control Knob to set the desired current value.
5. Repeat this procedure for the remaining presets if desired.
6. Move the Recall Switch from the SET to the PRESET position to store changes.

Note: Presets reside in non-volatile memory meaning that the voltage and current settings for each preset are retained even when the power supply is switched OFF.

Caution: Check the output voltage of the preset in use before connecting to the Load. To check a preset value, move the Mode Switch to the PRESET position and then move the Recall Switch to the P1, P2 or P3 position. The Voltage and Current settings for the corresponding preset will display.

To reset the preset outputs to the factory default state:

1. Press and hold the Voltage Control knob for 30 seconds to access the menu.

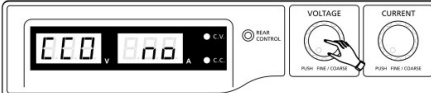

2. When the display is showing 'CCO', rotate the Voltage Control knob until the voltage meter shows 'rPr'.

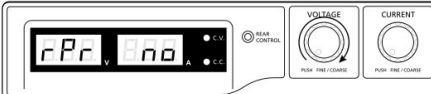

3. With the Current meter showing 'no', rotate the Current Control knob until the Current meter shows 'YES'.

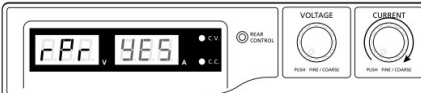

4. Press the Current Control knob once to confirm.

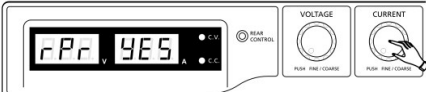



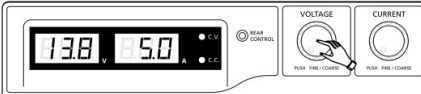









5. Press the Voltage Control knob to exit the menu

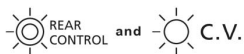

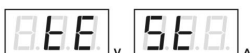
Power up Checks

1. First, check the rating label of the power supply and make sure it complies with the AC mains voltage (110V or 220V). Next, set the Mode Switch located on the rear of the power supply to the Normal Position.
2. Listen for the cooling fan when switching on the power supply. The power supply performs a series of self test checks on startup which includes testing the cooling fan. The fan will stop completely after a few seconds after running at high speed indicating that it is in good order. The **CV**, **V** and **A** lights switch ON displaying voltage and 0.0 current. To check the current level, turn the control knob one click in either direction. The current display returns to 0.0 after a few seconds.

The Table below illustrates the Self-Test sequence:

Self test display and Sequence	Test Description
	Software version
	Display check
	C.V. Indicator check
	C.C. Indicator check
	Rear indicator check
	C.V. recheck
	Test continuing
	Over voltage protection check
	Over load protection check
	Over temperature protection check
	Fan check
	Output off (remote control mode)

Operation

WARNING: Do not use this power supply with electric motors for any reason or for charging purposes on electroplating equipment or similar devices. Return EMF and voltage transients generated by electric motors can damage this power supply. This power supply was designed for use on electronic equipment only and not intended for use on electrical equipment of any kind.

Using the Control Knobs

The rotary control knobs offer fine/coarse tuning with notched movement.

1. Push the knobs to toggle between coarse and fine tuning, notice the subtle changes in brightness of the related LED.
2. Adjust the knobs to the desired values by using coarse and then fine tuning. The display will resume its normal brightness after a few seconds to confirm the adjustment.

Connecting to UUT (Unit under test)

1. Connect the equipment to the power supply. Red (+) is connected to the positive polarity input of the UUT and Black (-) is connected to the negative polarity input of the UUT.
2. Switch ON the power supply first; the panel meter & green CV Indicator should switch ON.
3. Switch ON the UUT; the panel meter & green CV Indicator should remain on.
4. The UUT is now ready. When operation is completed, switch off the UUT and then the power supply.
5. When disconnecting the power supply from the UUT, disconnect the remote sensing wire first and then disconnect the output cables.

Manual Zero Function

The power supply automatically zeroes the current metering upon power-up. To manually run a zero function without having to cycle power:

1. Press and hold the Voltage Control Knob for 30 seconds to open the menu.

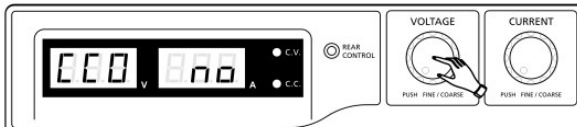

2. Rotate the Current Control knob until the meter shows the following:

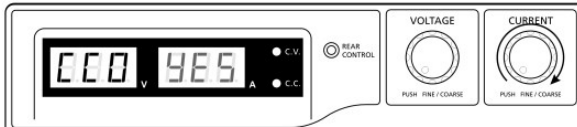

3. Press the Current Control knob once to confirm. The display will show 'YES'.

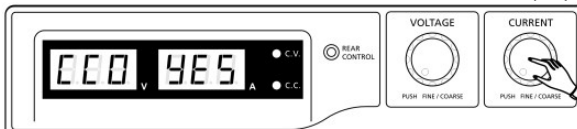

4. Press the Voltage Control knob to exit the menu.

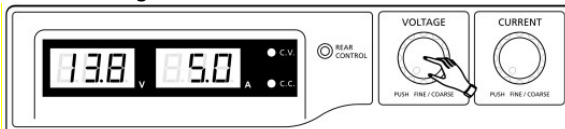

Remote Control

Remote control is made possible through the use of the supplied 8-pin Remote Control connector and 22AWG wire. The Remote Control feature offers remote adjustment of voltage and current and output ON/OFF switching.

Remote ON-OFF Control

The Remote Control ON-OFF function can be activated in any of the operational modes (NORMAL, PRESET, REMOTE, and SET). Using the supplied 8-pin plug and 22AWG wire, follow the procedures below:

1. Remove the black portion of the remote control connector plug by removing the screw as shown.

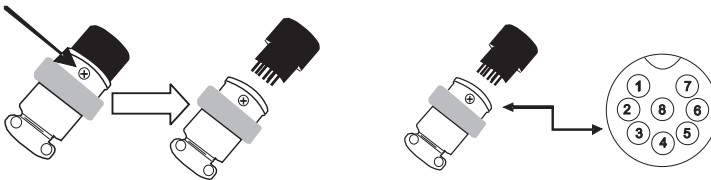

2. If PIN 5 is open, the output is ON.
3. If PIN 5 is shorted to ground (PIN 4) the output is OFF.
4. When the output is OFF, the C.V. & C.C. LED will flash. The current output voltage and current setting will show on the panel meter.
5. The output voltage & current control knob can be used to adjust to the desired value when the output is off.

Remote Voltage/Current Control

There are two methods (Method A and Method B; see below) for the remote adjustment of voltage and current. Each method requires that the Current remote control portion be functional otherwise the unit will be in the CC mode all of the time.

Remote Control Method A: Using two external variable DC voltage sources

A variable external voltage source of 0 ~ 5VDC is fed into the remote control terminal to adjust the output voltage level.

Warning! Do not input voltage higher than 5V, otherwise the Over Voltage Protection (OVP) will be triggered.

1. Ensure that the load is disconnected and that the power supply is OFF.
2. Use **ONLY** the wires from Port 2 (Positive) and Port 4 (Negative)
3. Switch on the power supply.
4. Vary the external input voltage 0~5V to check and verify the full output voltage range of the supply.
5. Short the main output with 10AWG wire to check the CC display by varying the external voltage source.
6. Switch OFF the power supply.

Remote Socket PIN assignment for external variable voltage source		
PIN	FUNCTION	NOTES
1	Internal +5VDC	50mA maximum
2	Voltage Adjustment	0 to 5V
3	Current Adjustment	0 to 5V
4	Ground	
5	Output OFF	Short to ground
6	Unused	
7	Unused	
8	Unused	

Remote Control Method B: Using two external variable 5k ohm resistors

1. Ensure that the load is disconnected and that the power supply is OFF.
2. Prepare two 5k ohm variable resistors as shown in the diagram below and use the wires from Port 1, 2 and 4 as shown.
3. Switch the power supply ON.
4. Adjust the Pin 2 5k ohm variable resistor from one end to other end to check and verify the full output voltage range of the power supply.
5. Short the main output with 10AWG wire and check the CC display by adjusting the Pin 3 5k ohm variable resistor.
6. Switch OFF the power supply.

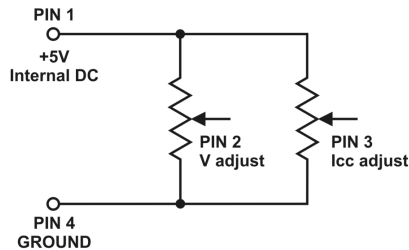

Remote Socket PIN assignment for external variable resistors		
PIN	FUNCTION	NOTES
1	Internal +5VDC	
2	Voltage Adjustment	Variable part of resistor
3	Current Adjustment	Variable part of resistor
4	Ground	
5	Output OFF	Short to ground
6	Unused	
7	Unused	
8	Unused	

Overload Protection

OUP: Over Voltage Protection



This unit has a built-in over-voltage protection feature. In the event of an output voltage exceeding the allowable range (refer to the specifications section for range limits), protection will be triggered and the output power will be switched off. (OUP warning appears).

To reset the warning, switch off the power supply and remove all loading. Switch the unit to resume normal operation. If this problem persists, please contact Extech Technical Support.

OTP: Over Temperature Protection



The unit houses a thermo-sensor that monitor to determine if an over-heating condition exists. The OTP warning will appear on the display and the output will switch off in over-heating condition does exist. When this warning appears, switch off the unit and remove all loading.

In these cases, check the load and the output settings and then allow the unit to cool for at least 30 minutes.

Ensure that the ventilation openings are not blocked and that the power supply has proper clearance. Ensure that the cooling fan is operational; never use the power supply with a faulty cooling fan.

OLP: Over Load Protection



Normally the overload protection is provided by the CC constant current mode. However, if the CC mode fails it may cause serious damage to the test piece or to the load. OLP is used to minimize the extent of the damage to the load. Switch off the power supply as soon as this warning appears. To reset this warning, switch off the unit and remove all loading and then switch the unit on again. If this problem persists, please contact Extech Technical Support.

Maintenance and Repair Services

Cleaning the meter housing

Prior to cleaning the meter housing, disconnect the mains plug from the power outlet. Clean only with a damp, soft cloth and a commercially available mild household cleaner. Ensure that no water gets inside the equipment to prevent possible shorts and damage to the equipment.

Specifications

Rear Output	Variable Output Voltage	1 to 30VDC
	Variable Output Current	1 to 20A
Voltage Regulation	Load (10 to 100% Load)	50mV
	Line (170 to 264VAC)	20mV
Current Regulation	Load (90 to 10% Rated Voltage)	100mA
	Line (170 to 264VAC Variation)	50mA
	Ripple & Noise (peak-peak) Voltage	50mV
	Current Ripple & Noise (rms)	30mA
Front Output	Variable Output Voltage	1 to 30VDC
	Variable Output Current	1 to 5A
Voltage Regulation	Load (10 to 100% Load)	350mV
	Line (170 to 264VAC)	20mV
Current Regulation	Load (90 to 10% Rated Voltage)	100mA
	Line (170 to 264VAC Variation)	50mA
	Ripple & Noise (peak-peak) Voltage	50mV
	Current Ripple & Noise (rms)	30mA
Meter Accuracy	Voltage Meter	$\pm(0.2\% +3 \text{ digits})$
	Current Meter	$\pm(0.2\% +3 \text{ digits})$
Tracking Over Voltage Protection	1 to 5V	Default Value is +2V
	5 to 20V	Default Value is +3V
	20 to 30V	Default Value is +4V

Input Voltage	100 to 120VAC 50/60Hz (Model 382275) 210 to 230VAC 50/60Hz (Model 382276)
Rated Load Input Current	3.1A Model 382276) 5.9A (Model 382275)
Efficiency	87% at optimal load
Switching Frequency	75 to 95 KHz
Cooling Method	Thermostatic Control Fan from Zero to full speed
Protections	Overload, Short Circuit by Constant Current, Output Tracking Over Voltage, Over Temperature
Transient Response Time	1.5ms (50-100% of load)
Power Factor Control	>0.95 at optimal load
Special Features	Three (3) user defined presets and Remote Control
Operating Humidity Range	10 to 80%RH
Altitude	2000 meters (7000 Feet)
Pollution Degree	2
Main Supply Voltage Fluctuation	±10% of the nominal voltage
Dimensions (WxHxD)	200 x 90 x 215 mm (7.9 x 3.5 x 8.5")
Weight	2.6 kg (5.7 lbs)
Approvals	CE EMC: EN 55011, 55022 LVD: EN 60950, 61010

Copyright © 2014-2015 FLIR Systems, Inc.

All rights reserved including the right of reproduction in whole or in part in any form.
www.extech.com