

True RMS AC/DC Mini Clamp Meter

Model 380947

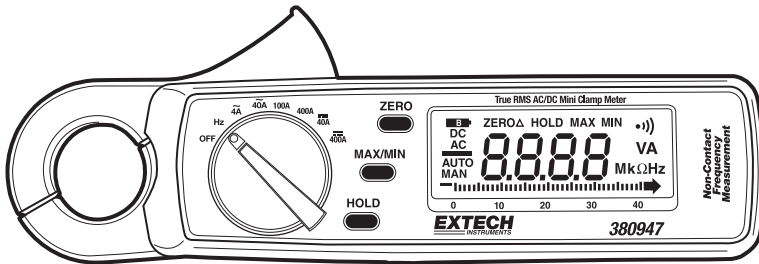







Introduction

Congratulations on your purchase of the Extech 380947 True RMS Clamp Meter. This Clamp meter measures current up to 400A DC/AC and measures Frequency up to 100 kHz. Careful use of this meter will provide years of reliable service.

Safety

1. **NEVER** exceed the specified voltage/current maximum
2. **USE EXTREME CAUTION** when working with high voltages.
3. **NEVER** operate the meter unless the back cover and the battery/fuse door are in place and fastened securely.

International Safety Symbols

	DC Voltage DC Current		Refer to explanation in owners manual
	AC Voltage AC Current		Dangerous voltage risk of electrical shock
	Ground		Double Insulation

Meter Description

1. Conductor under test
2. Clamp Jaws
3. Jaw trigger – Opens the meter jaws
4. ZERO / Relative button – Zeroes the DCA reading
5. Function select switch
6. HOLD button to freeze displayed reading
7. MAX/MIN button – Press to track and view highest and lowest readings
8. LCD Display with function indicators, units of measure, and bargraph

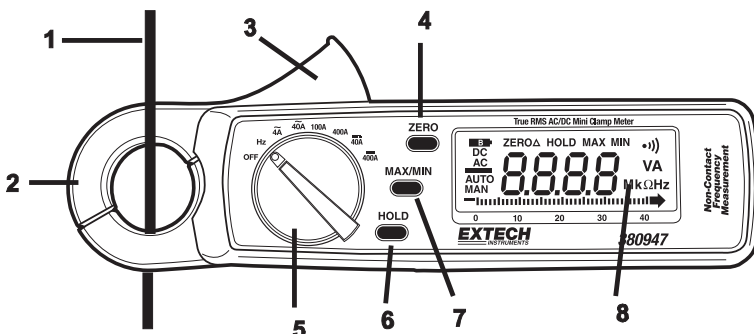

Display icons

B	Low battery
DC	Direct current
AC	Alternating current
—	Minus sign
AUTO	Automatic range (frequency only)
APO	Auto power off
ZERO	Zero function
HOLD	HOLD function
MAX	Highest reading
MIN	Lowest reading
A	Current unit of measure
M	Prefix MEGA (millions of units)
k	Prefix KILO (thousands of units)
Hz	Hertz (unit of measure for frequency)
OL	Over-range (for readings above 4032)

Bargraph display

The 40 segment bargraph display shown below is a graphical interpretation of the measurement. It is displayed under the display digits on the LCD.

The bars in the bargraph indicate a presence of an electronic signal. The more bars showing, the higher the signal. The digits below the graph help the user see how many bars are showing. If 40 segments are showing, the bars will reach the '40' mark, if 20 bars are showing the bars will reach the '20' mark.

The bargraph is to be interpreted based on the range the meter is in while the measurement is being made. If the bargraph shows 40 segments lit, then the signal is at the highest end of the meter's present range.



Operation

AC Current Measurements

WARNING: To avoid electric shock, disconnect the test leads from the meter before making current measurements.

1. Set the Function switch to the 4, 40, 100, or 400A AC range.
2. Press the Trigger to open the clamp jaw.
3. Clamp onto a single conductor (fully enclosing it). Do not allow a gap between the two halves of the jaw.
4. Read the ACA value on the LCD.

DC Current Measurements

WARNING: To avoid electric shock, disconnect the test leads from the meter before making current measurements.

1. Set the Function switch to the 40 or 400A DC range.
2. Press the DCA zero key to null the meter display.
3. Press the Trigger to open the current sense Jaw.
4. Fully enclose a single conductor to be measured. Do not allow a gap between the two halves of the jaw.
5. Read the DCA value on the LCD.

Frequency Measurements

1. Ensure that at least 0.1A AC is detectable before measuring Frequency.
2. Set the Function switch to the Hz position.
3. Press the Trigger to open the jaw and fully enclose one conductor.
4. Read the Frequency measurement on the LCD in Hz.

MIN, MAX Function

Pressing the MIN/MAX key allows the meter to display ONLY the highest and the lowest readings encountered. Press the MIN/MAX key once to view the minimum reading, press it again to view the maximum reading. The LCD will toggle between the MIN and MAX values. Press and hold MIN/MAX button for more than 2 seconds to return to normal operating mode. Zero function will be disabled when MIN/MAX is enabled. MIN/MAX is not available in Hz mode.

Data Hold

To freeze the displayed reading on the LCD, press the Data Hold key (the HOLD icon will appear on the display). To release the Data Hold function and return the meter to normal operation, press the Data Hold key again (the HOLD icon will switch off).

Zero button for Relative Measurements

- 1) Press the Zero key and the present measurement will Zero.
- 2) All subsequent measurements are displayed with respect to the zeroed reading. For example, if a 20A reading is zeroed and a 30A reading is subsequently measured, the LCD will display 10A.
- 3) To return to normal operation, press the zero key one more time.
- 4) Note that Relative mode is not available if the MIN/MAX mode is enabled.
- 5) Relative mode is not available in Hz mode.
- 6) Note that the Zero button is disabled if Hz function is selected.
- 7) LCD displays relative numerical value without bargraph.

Battery Replacement

1. When the low battery symbol appears on the LCD, the batteries must be replaced.
2. Turn the meter off and remove the rear battery compartment screw.
3. Lift off the battery compartment cover and replace the two 1.5V AA cells.
4. Replace the compartment cover and secure the screw.



You, as the end user, are legally bound (**EU Battery ordinance**) to return all used batteries, **disposal in the household garbage is prohibited!** You can hand over your used batteries / accumulators at collection points in your community or wherever batteries / accumulators are sold!

Disposal: Follow the valid legal stipulations in respect of the disposal of the device at the end of its lifecycle

Cleaning - Use only a dry cloth to clean the plastic case.

Specifications

General Specifications

Display	3-3/4 Digit LCD with 40 segment bargraph
Functions	Current (ACA, DCA) and Frequency (Hz)
Polarity	“-“ indicates negative polarity (positive polarity assumed)
Current sensor	Hall effect
Overload	OL
DCA zero adjust	One-touch zero key (also used as a Relative function)
Display rate	3 readings/second (30 readings/second for bargraph)
Battery	Two 1.5V AA batteries
Operating temperature	-10°C to 50°C (4°F to 122°F)
Operating Humidity	< 85% RH
Power consumption	20mA DC approx.
Weight	190g (6.2 oz.) including battery
Dimensions	183 x 63.6 x 35.6mm (7.2 x 2.5 x 1.4”) (H x W x D)
Jaw opening	23mm (0.9”)
Standards	IEC 1010 Category III 300V, Category II 600V

Range Specifications

DC Current	Resolution	Accuracy (of rdg + digits)		Overload Protect
40A	10mA	$\pm(1.0\% + 2d)$		400A DC
400A (0 to 150A)	100mA	$\pm(1.0\% + 2d)$		400A DC
400A (150 to 200A)	100mA	$\pm(2.2\% + 2d)$		400A DC
400A (200 to 400A)	100mA	$\pm(4.0\% + 2d)$		400A DC
AC Current	Resolution	50/60Hz	40Hz - 1kHz	Overload Protect
4A (0 to 500mA)	1mA	$\pm(1.5\% + 7d)$	$\pm(2.0\% + 7d)$	400A AC
4A (500mA to 4A)	1mA	$\pm(1.5\% + 3d)$	$\pm(2.0\% + 4d)$	400A AC
40A	10mA	$\pm(1.5\% + 3d)$	$\pm(2.0\% + 4d)$	400A AC
100A (0 to 100A)	100mA	$\pm(1.5\% + 3d)$	$\pm(2.0\% + 4d)$	500A AC
400A (100 to 200A)	100mA	$\pm(2.2\% + 3d)$	$\pm(2.5\% + 4d)$	500A AC
400A (200 to 400A)	100mA	$\pm(4.0\% + 3d)$	$\pm(5.0\% + 4d)$	500A AC
Frequency (Hz)	Resolution	Accuracy	Sensitivity	Overload Protect
40Hz to 250Hz	0.01 to 0.1Hz	$\pm(0.5\% + 2d)$	3.0A	500A AC
250Hz to 10kHz	0.1 to 1Hz	$\pm(0.5\% + 2d)$	0.3A	500A AC

Copyright © 2014 FLIR Systems, Inc.

All rights reserved including the right of reproduction in whole or in part in any form

www.extech.com