

OPERATION MANUAL

PEN TYPE PH METER

DESIGN PATENTED:
US D453.905S



CE

Model: 8690

INTRODUCTION

Congratulations on your purchase of the unique shape of pH pen model 8690, the meter features dual display pH with ATC (Automatic Temperature Compensation), only one touch for auto-calibration, easy read by 45° angle, the pH electrode module is replaceable.

Read completely before using the meter, file and keep this manual for future reference. Recommend soak the electrode for at least 30 min. before using, especially if the electrode dries out between uses or after long time unuses.

DISPLAY

The meter will display all LCD segments when it is first turned on for approx. 1 seconds.

- The primary display shows the measured pH reading.
- The secondary display shows the reading of temperature .
- The left corner display shows the Calibration **CAL** and Auto Temperature Compensation **ATC** of the reading.
- Unit of °C or °F is displayed at the right corner of the screen.

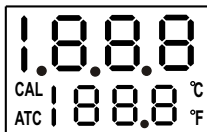

CONTROLS AND INDICATORS

1. Primary Data Screen displays pH reading, calibration value.
2. Secondary Data Screen displays temperature reading.
3. °C/°F Toggles display data from °C to °F or °F to °C.
4. Replaceable pH Electrode .
5. Cover of the pH pen .
6. Glass bulb (protect by transparent plastic cover)
7. Pocket clip.
8. CAL-Calibration indicator.
9. ATC-Auto Temp. Compensation.
10. Tab for releasing from the lock.
11. HOLD , UNIT selectable button.
12. CAL ▲ button.
13. Power ON /OFF button.

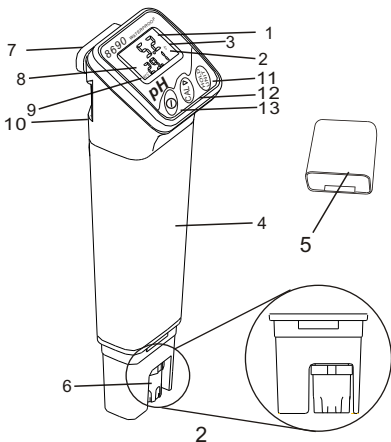

1. Remove the cap from the bottom of the meter to expose the electrode which is protected by a small transparent plastic cover. It is normal if you find white crystals are present on the cap or electrode assembly. Rotate the small cap in clockwise direction to expose the electrode. DON'T pour out the liquid in the small cap, the liquid is used to keep electrode wet. (See below figure.)
2. Dip the electrode into the test solution and stir it to get a stable reading .
3. A small dot "●" is flashing while the meter is working, the screen shows pH value and solution temperature (ATC) with unit °C or °F. See Fig.G.

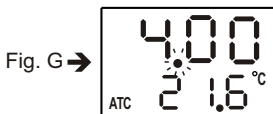

4. Press **HOLD** button to freeze the current reading. The small dot is not flashing after pressing the button.

5. Turn off by pressing ① button .

6. To disable the sleep mode before power on, see the procedure on page 4.

7. Put back the transparent cover and gray cap to store the pH pen under the temperature 0~50 °C.

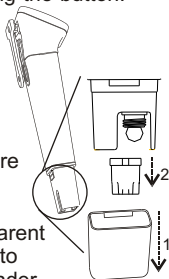

AUTO POWER OFF (SLEEP FUNCTION)

This instrument will shut off automatically in approx. 20 minutes for every power on. For recording or operating over longer periods of time, you can disable the sleep mode by pressing $\text{\textcircled{1}}$ and $\text{\textcircled{HOLD}}$ keys at the same time before power on and then release the power key. An "n" will appear in the middle of the screen for one second (See Fig.A) and return to the normal mode. (See Fig. B) Note: The disable sleep mode will be invalid after power off.

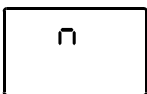
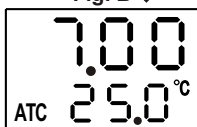

Fig. A \uparrow









MODE OPTIONS

The three keys of the meter enable user to select the modes they prefer.

The display will default to the mode last used. For your convenience, the meter defaults to the setting used during the last operation. The following content lists the modes of operation that can be activated by pressing the keys indicated.

- $\text{\textcircled{1}}$ -Turns instrument on (Default setting) and off (See Fig. B).
- When the meter is off, press this key and $\text{\textcircled{HOLD UNIT}}$ simultaneously to disable sleep mode (See Fig. A).
- Press this key and $\text{\textcircled{CALV}}$ to enter unit setting. See the procedure in page 5

 -Press this key to increase the value when meter is in pH calibration mode. Release the key after selecting the correct calibration value (Fig. E).

 -When meter is on, short press to enter the calibration mode(Fig. F).
-When in calibration mode, skip to next calibration point by pressing this key.
-When metetr is off, press this key and  at the same time and then release the  to enter unit setting. Press  to select °C or °F (Fig.D). Then, press  button to store the unit, the display shows "SA" for one second (See Fig.J) and then return to the normal mode .



↑ Fig. C

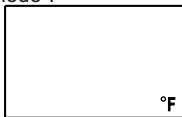
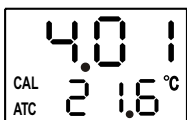

Fig. D ↑



↑ Fig. E

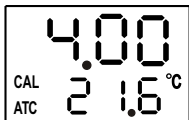



Fig. F ↑

AUTOMATIC TEMPERATURE COMPENSATION (ATC)

The meter is capable of taking measurements with Automatic Temperature Compensation. "ATC" shows under "CAL" at the left corner of the screen.

CALIBRATION MODE (CAL)

Calibration is necessary and should be done regularly, recommend every day if the meter is used very often.

1. Power on the meter.
2. Short press  key to enter pH calibration mode, you will first see "4.00" on the LCD readout. (Fig. G).
3. **NOTE:**
If the buffer is incorrectly inserted or the probe is damaged, "CAL" will not flash on above "ATC" .(See Fig.G)
4. After about 60 "CAL" flashes or 60 seconds, the meter will automatically save and "SA" shows for one second, then skip to next calibration point without pressing any button .
5. At the moment, the screen shows 7.00 (Fig.H), CAL is not flashing until you remove the meter to the correct calibration buffer. CAL again flash repeatedly about another 30 seconds, then save the calibration point automatically: "SA" shows for 1 second and skip to "10.00" (remember to use the correct buffer), "CAL" is flashing again .(See Fig. I)

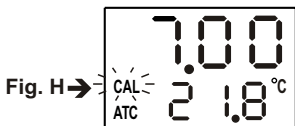

6. There are 3 calibration points 4.00, 7.00 and 10.00, after completing the last calibration point 10.00, the meter return to the normal mode after saving automatically (See Fig.K) .LCD shows "End " for a second (See Fig. IA) .



↑ Fig. I

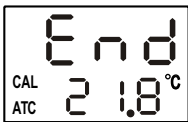



↑ Fig. IA



↑ Fig. J



Fig. K ↑

7. If want to calibrate "7.00" first before "4.00", pressing  to select the desired calibration point. "CAL" is not flashing while changing the value.
8. The meter designs with an adjustable calibration point to meet different solution standard. The adjustable cal . point range for 4.00 pH is from 3.50 to 4.50. Hold the  cycle from 3.5 to 4.5 then 3.5 again. Release the key when desired point is selected. The adjustable cal. range for pH 7.00 is 6.50~7.50. For 10.00 pH range, there are 9.50~10.5.
9. Rinse the probe with de-ionized water or a rinse solution (tap water...) after each measurement to lengthen the meter's life.

ELECTRODE REPLACEMENT

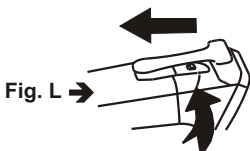

The meter features that you can replace the electrode module when needed (see Fig. L). Place the finger nail under the clip, pull up the tab to release the lock, push up the top part of the meter.

Pushing down the top part into a new electrode, align with the internal guides to lock the meter.

Now you have completed the electrode replacement .

REPLACING THE BATTERY

Replace your batteries when:

- ✓The readings on the display are flashing .
- ✓The meter will not power on.

Even if the battery was recently replaced, check its voltage level if you get no response from your instrument.

To replace the battery:

1. Remove the pH electrode module as above procedure (See Fig. L).
2. Replace the old batteries with two new button cell CR2032 (See Fig. LA).
3. Observe polarity and put back the top unit to the electrode module as above procedure, too (See Fig. L).

Remove battery from instruments that you do not plan to use for a month or more. Do not leave batteries in instrument.

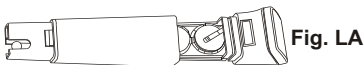

MAINTENANCE

- ✓ Please always keep the pH glass bulb wet by using the cap to protect and store the electrode.
- ✓ Always rinse the pH electrode and reference junction in de-ionized water before next use.
- ✓ Never touch or rub glass bulb for lasting pH electrode life.

TROUBLESHOOTING

- ? Power on but no display. Check the battery are in place and making good contact or correct polarity. Replace a new battery.
- ? Slow response. Clean probe by immersing the electrode in tap water for 10-15 minutes, then thoroughly rinse with distilled water or use a general purpose electrode cleaner.
- ? - - - - . Out of pH range, too acidic/or too alkaline. (Fig. M)
It is normal when the electrode is not immersed in the water.

➔ Fig. M

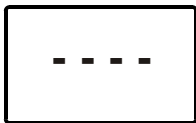

OPERATING CONDITIONS

- ✓ Operating temperature 0°~50°C (32~122°F)
- ✓ Operating Humidity Max. 80% RH
- ✓ Calibration buffer solution suggested:
 - USA buffers (pH 1.68, 4.01, 7.00, 10.01,12.45)
 - NIST buffers (pH 1.68, 4.01, 6.86, 9.18,12.45)
 - DIN buffers (pH 1.09, 3.06, 4.65, 6.79, 9.23, 12.75)

SPECIFICATION

	pH
Range	0.00 ~ 14.00
Resolution	0.01pH
Accuracy	±0.05pH at 25°C
Dimension	42 x 149 x 37 mm
Display	4 digits
Temperature compensation from 0 to 50°C , Accuracy :± 0.3°C	

MATERIAL SUPPLIED

This package contains:

- ✓ The meter x 1
- ✓ Battery x 2 (CR2032 button cell)
- ✓ Operation manual
- ✓ White plain box or Gift box
- ✓ Pouch x 1

OPTIONAL ACCESSORY:

- ✓ Replaceable pH electrode module (Model VZ86P9AZ). Pouch (Model VM68690B).

WARRANTY

The meter is warranted to be free from defects in material and workmanship for a period of one year from the date of purchase. This warranty covers normal operation and does not cover battery, misuse, abuse, alteration, tampering, neglect, improper maintenance, or damage resulting from leaking batteries. Proof of purchase is required for warranty repairs. Warranty is void if the meter has been opened .

RETURN AUTHORIZATION

Authorization must be obtained from the supplier before returning items for any reason. When requiring a RA (Return Authorization), please include data regarding the defective reason, the meters are to be returned along with good packing to prevent any damage in shipment and insured against possible damage or loss .

Accuracy, the Zenith of Measuring / Testing Instruments !

Hygrometer/Psychrometer

Thermometer

Anemometer

Sound Level Meter

Air Flow meter

Infrared Thermometer

K type Thermometer

K.J.T. type Thermometer

K.J.T.R.S.E. type Thermometer

pH Meter

Conductivity Meter

T.D.S. Meter

D.O. Meter

Saccharimeter

Manometer

Tacho Meter

Lux / Light Meter

Moisture Meter

Data logger

Temp./RH transmitter

Wireless Transmitter

More products available !

www.ponpe.com

2006/11 modified